

MARITORIUM

Meet Blue Sea | Maritorium | Laura Herndl, Michael Minton



SCHWARZPLAN WARNEMÜNDE ①

Meet Blue Sea | Maritorium | Laura Herndl, Michael Minton

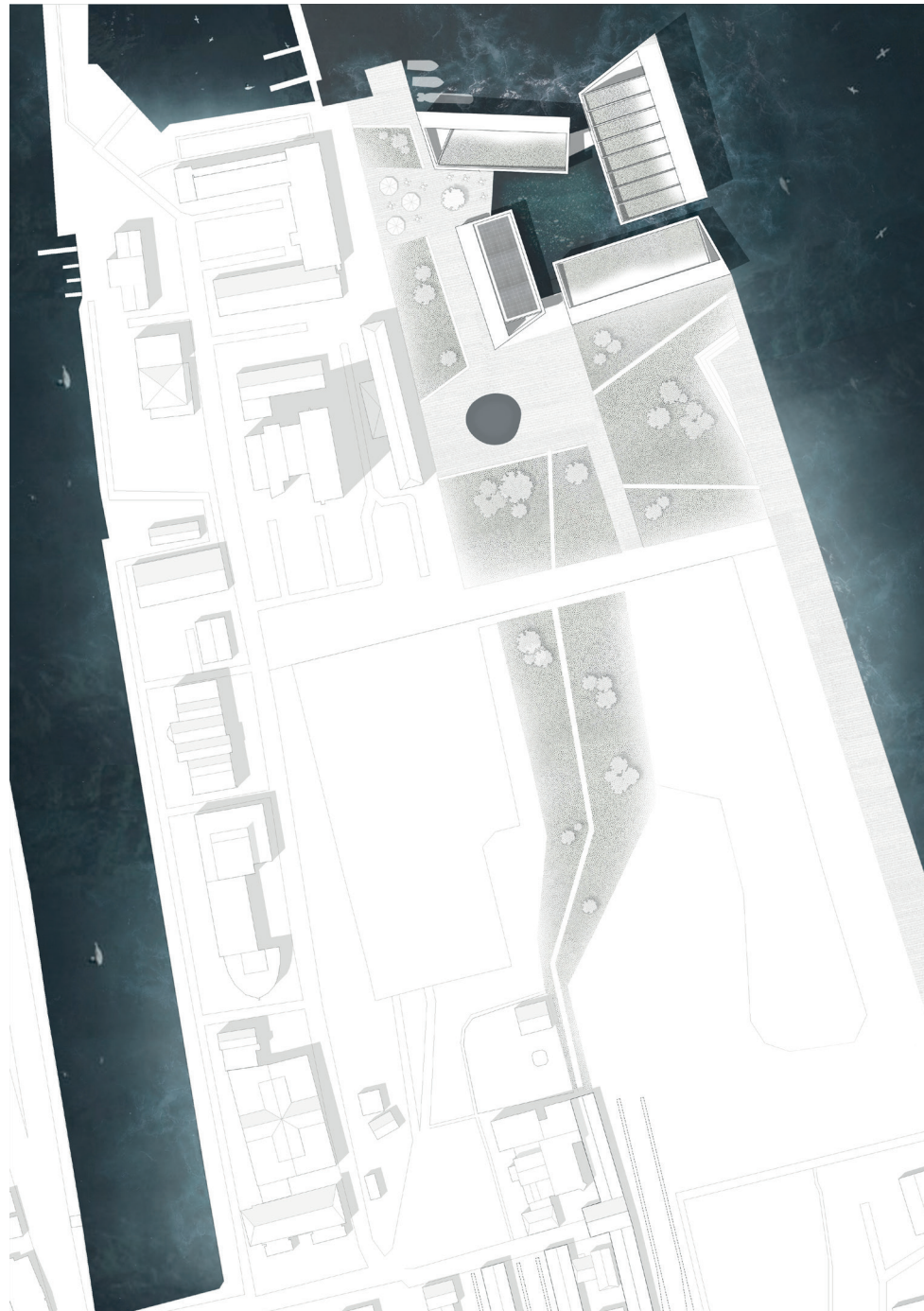

LAGEPLAN 

Meet Blue Sea | Maritorium | Laura Herndl, Michael Minton

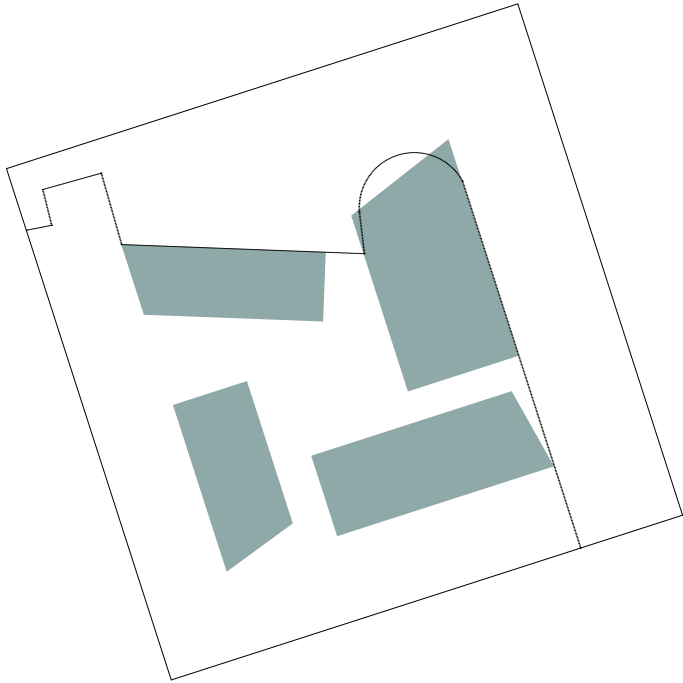

KONTEXT

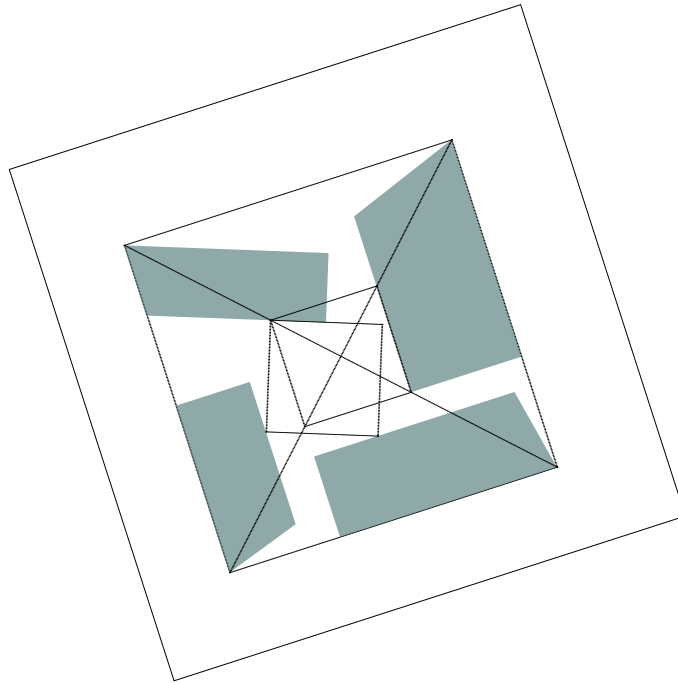

KOMPOSITION

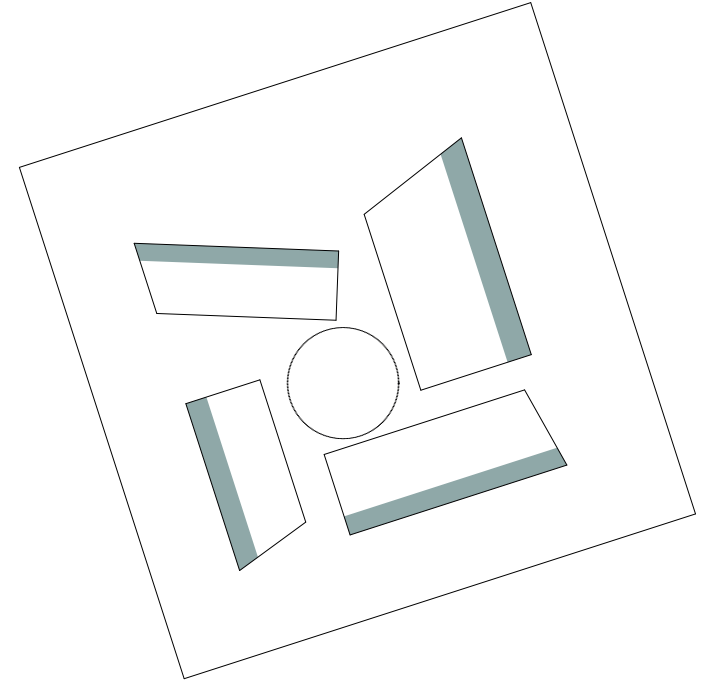

PRINZIP

KONZEPT

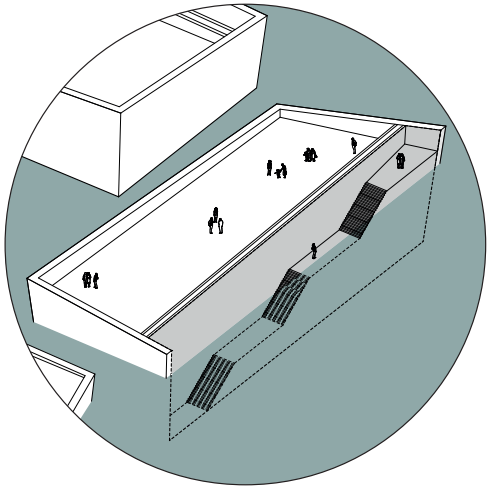

Dystopie

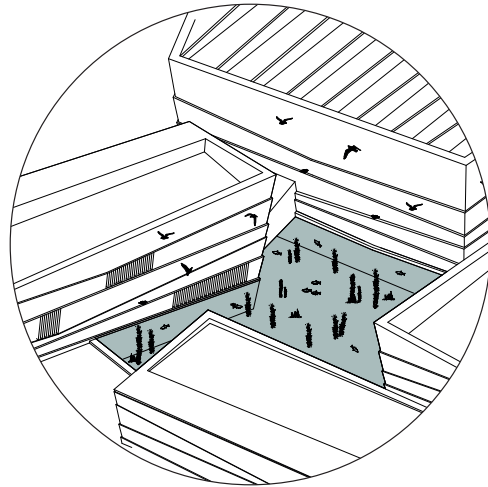

Habitat

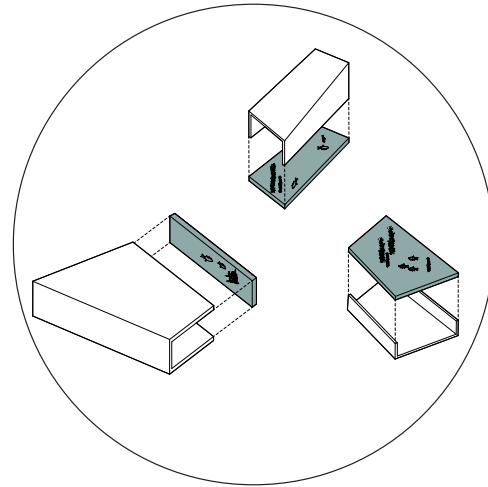

Übergänge

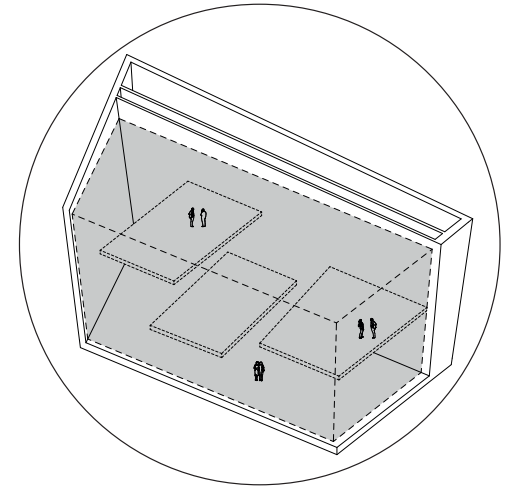

Flexibilität

KONZEPT

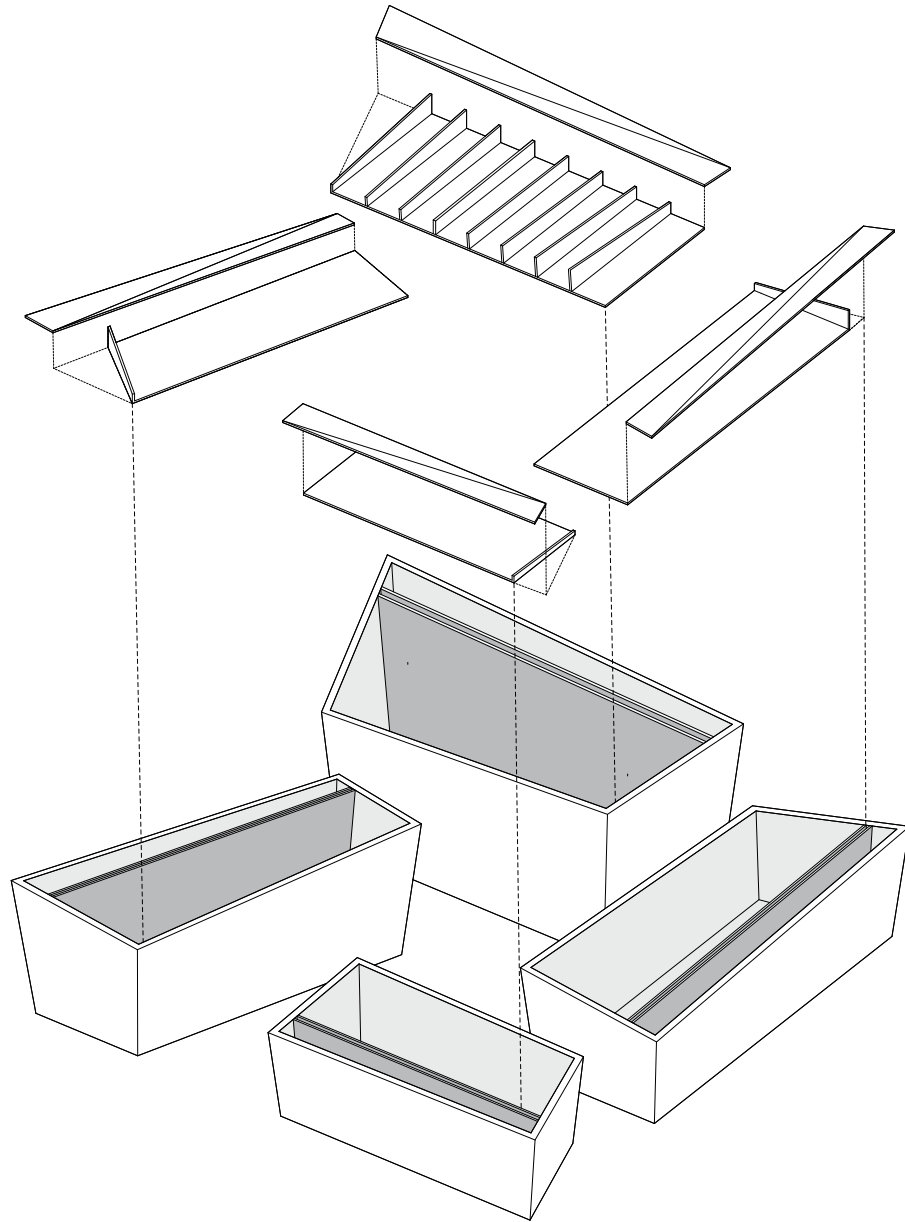

Entwässerung

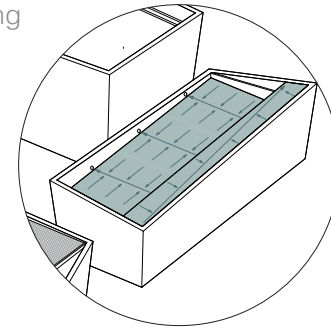

Dachbegrünung

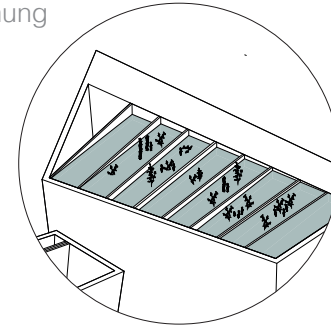

Solarpanele

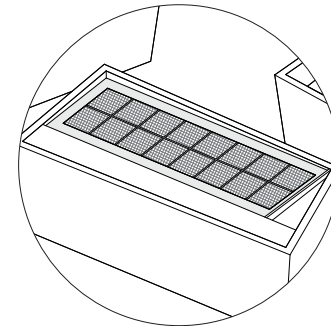

Wellenkraftwerk

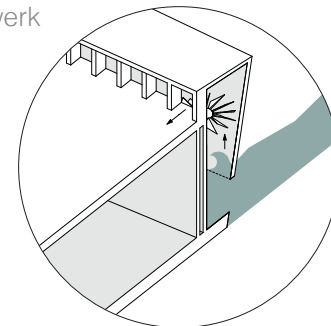

TRAGWERKSTECHNISCHES KONZEPT | ENERGIEKONZEPT

Meet Blue Sea | Maritorium | Laura Herndl, Michael Minton

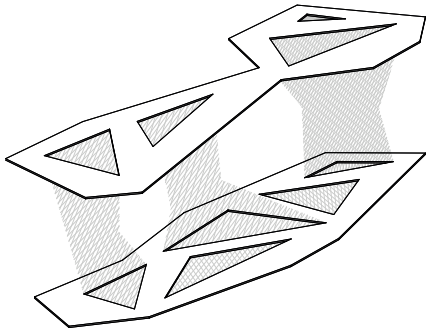

Ausstellung 1 „Überfischung“

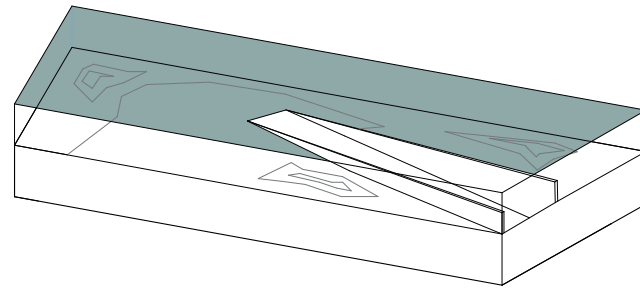

Ausstellung 2 „Plastikmüll im Ozean“

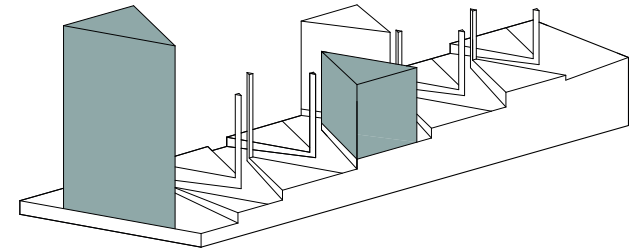

Ausstellung 3 „Meeresforschung“

AUSSTELLUNGSKONZEPT

Meet Blue Sea | Maritorium | Laura Herndl, Michael Minton

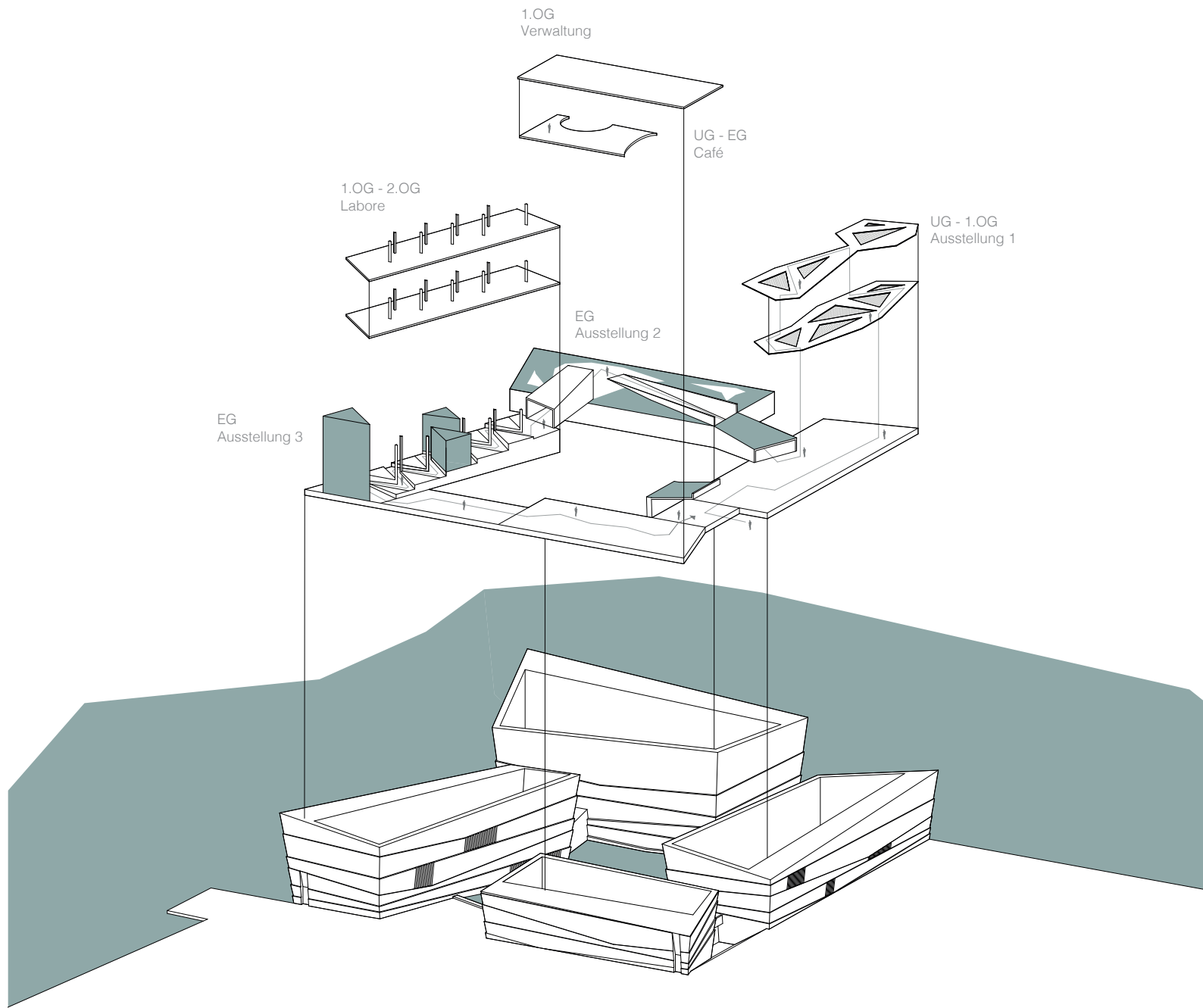

ERSCHLIESSUNGSKONZEPT

Meet Blue Sea | Maritorium | Laura Herndl, Michael Minton

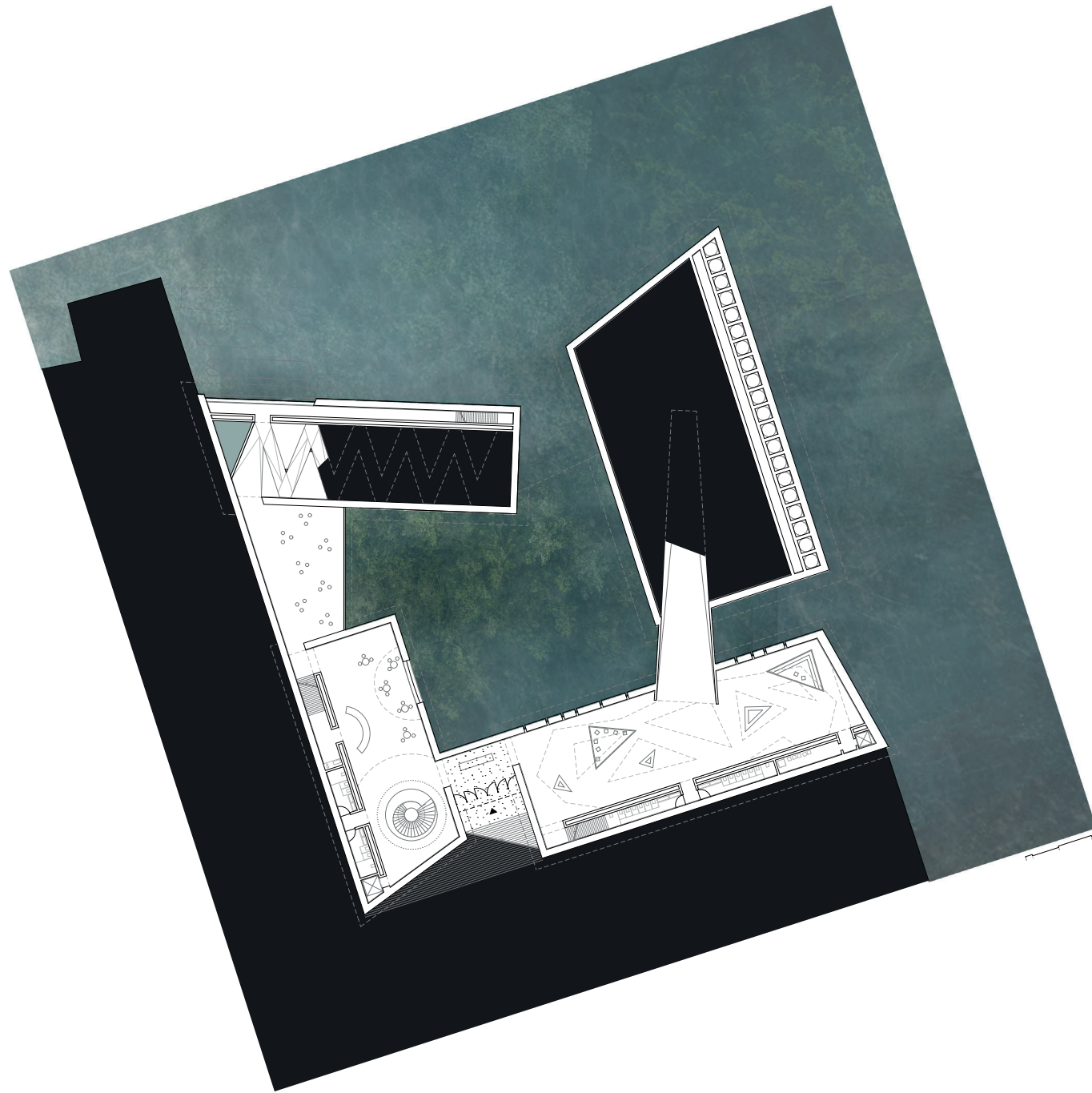

-GRUNDRISS 1.UG

Meet Blue Sea | Maritorium | Laura Herndl, Michael Minton

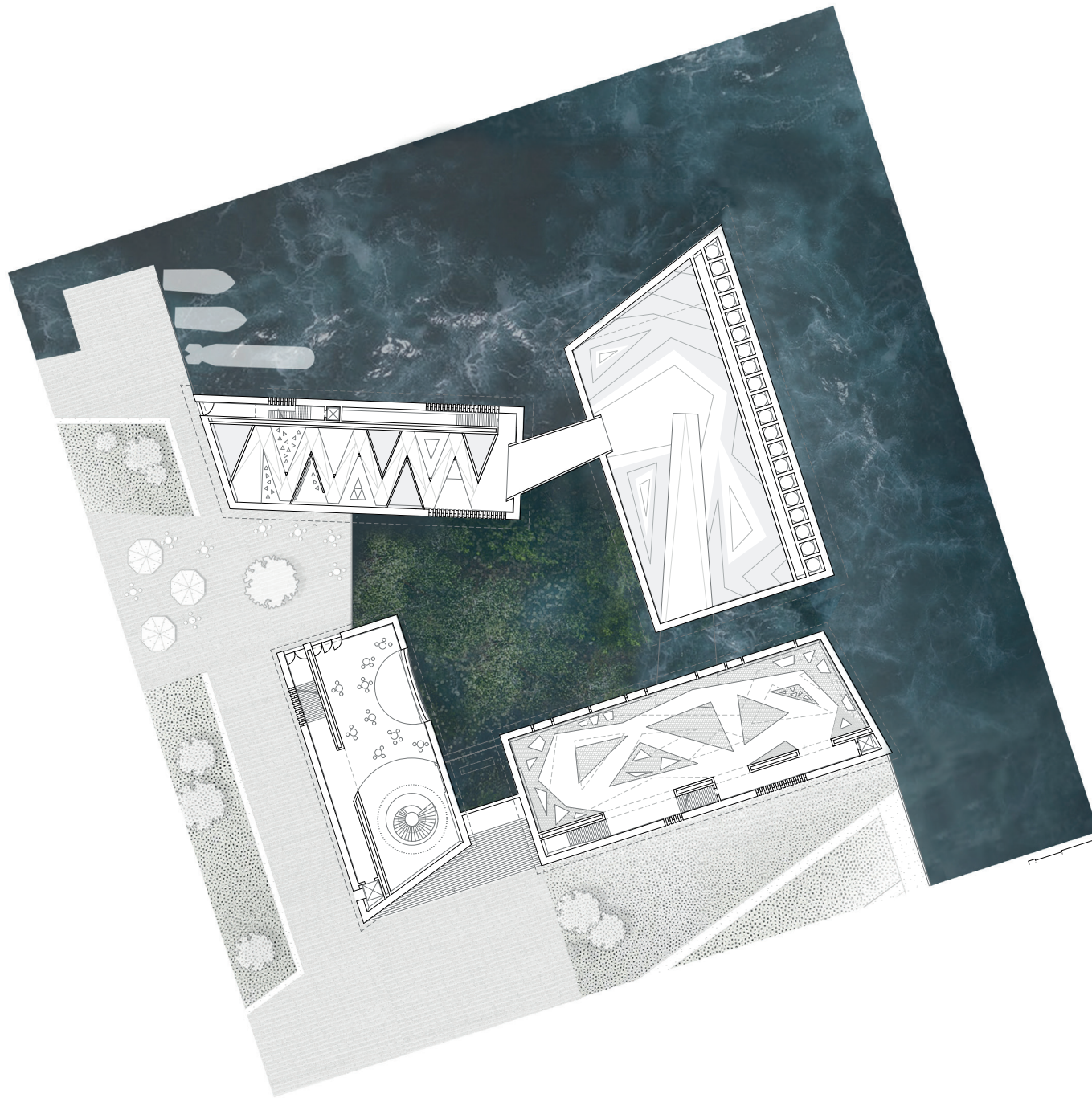

GRUNDRISS EG

Meet Blue Sea | Maritorium | Laura Herndl, Michael Minton

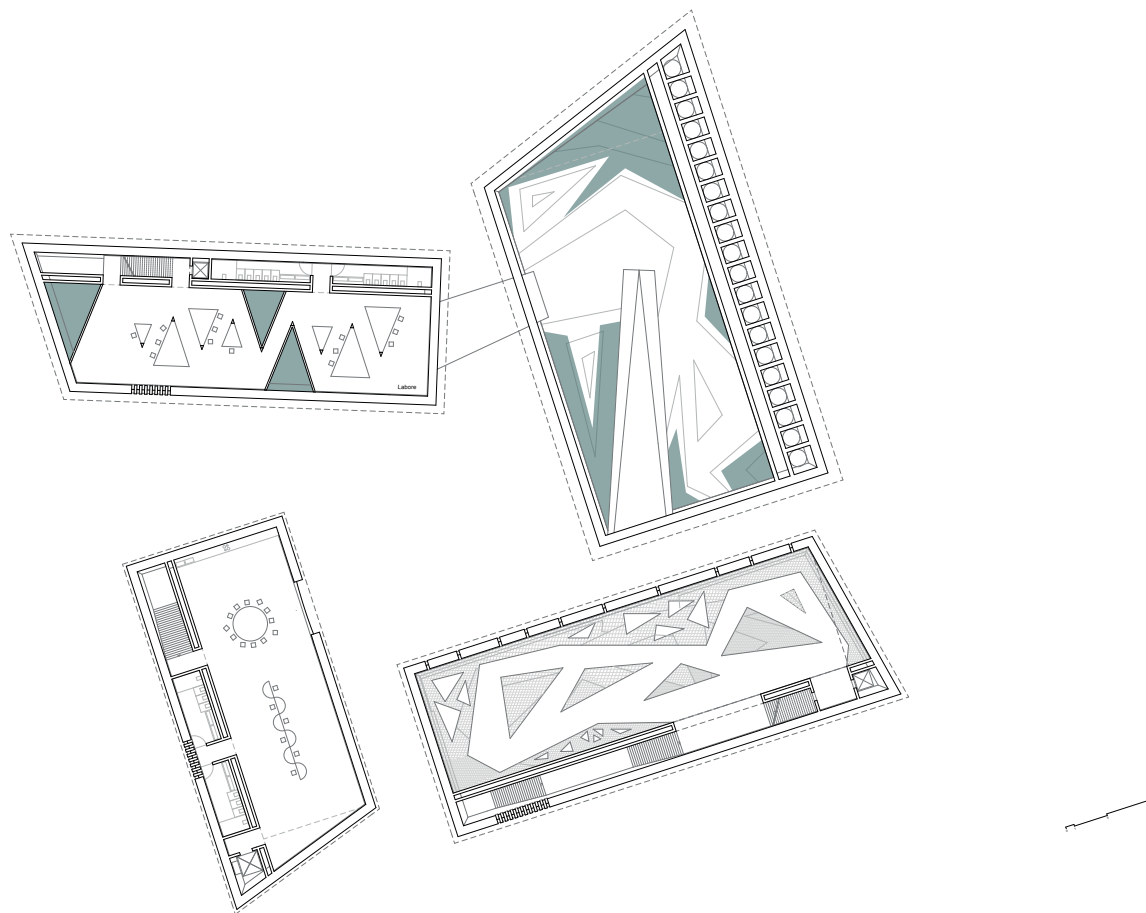

GRUNDRISS 1.OG

Meet Blue Sea | Maritorium | Laura Herndl, Michael Minton

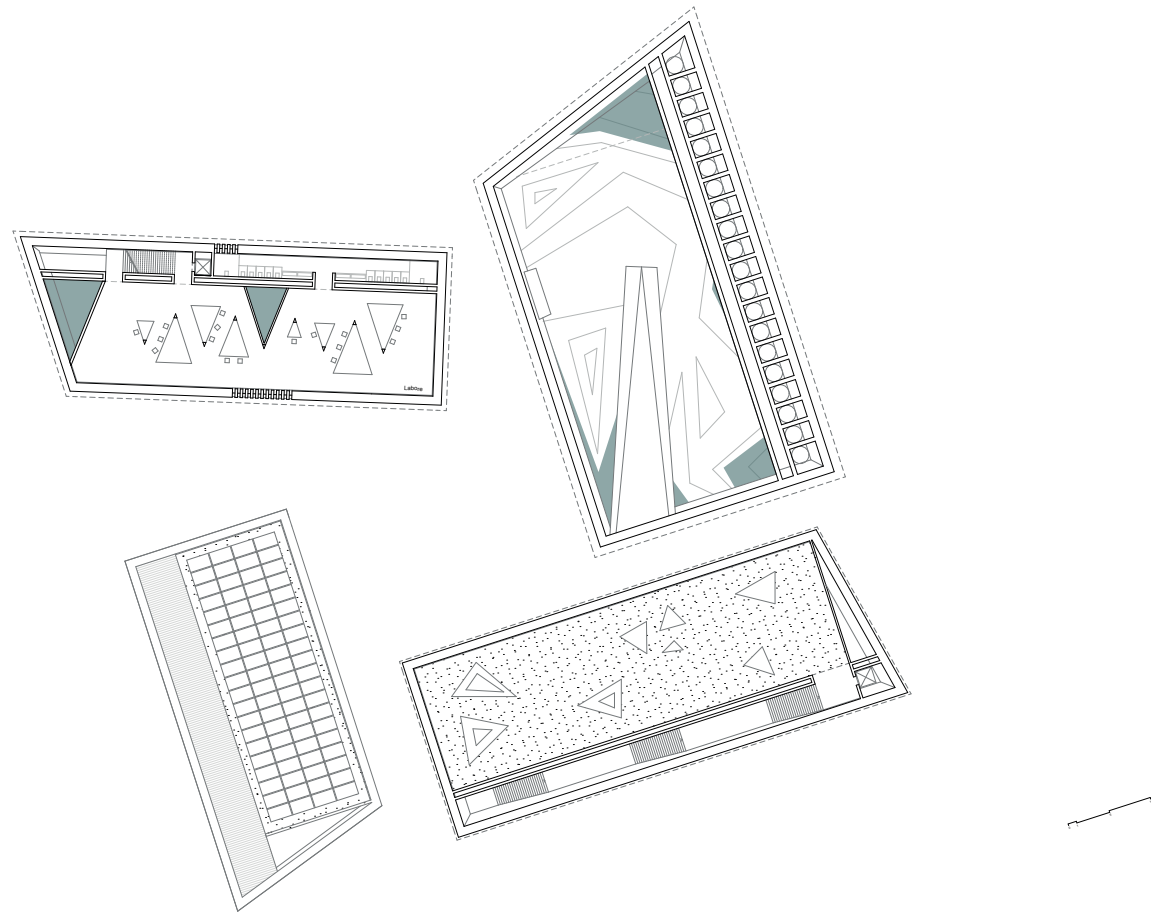

GRUNDRISS 2.OG

Meet Blue Sea | Maritorium | Laura Herndl, Michael Minton

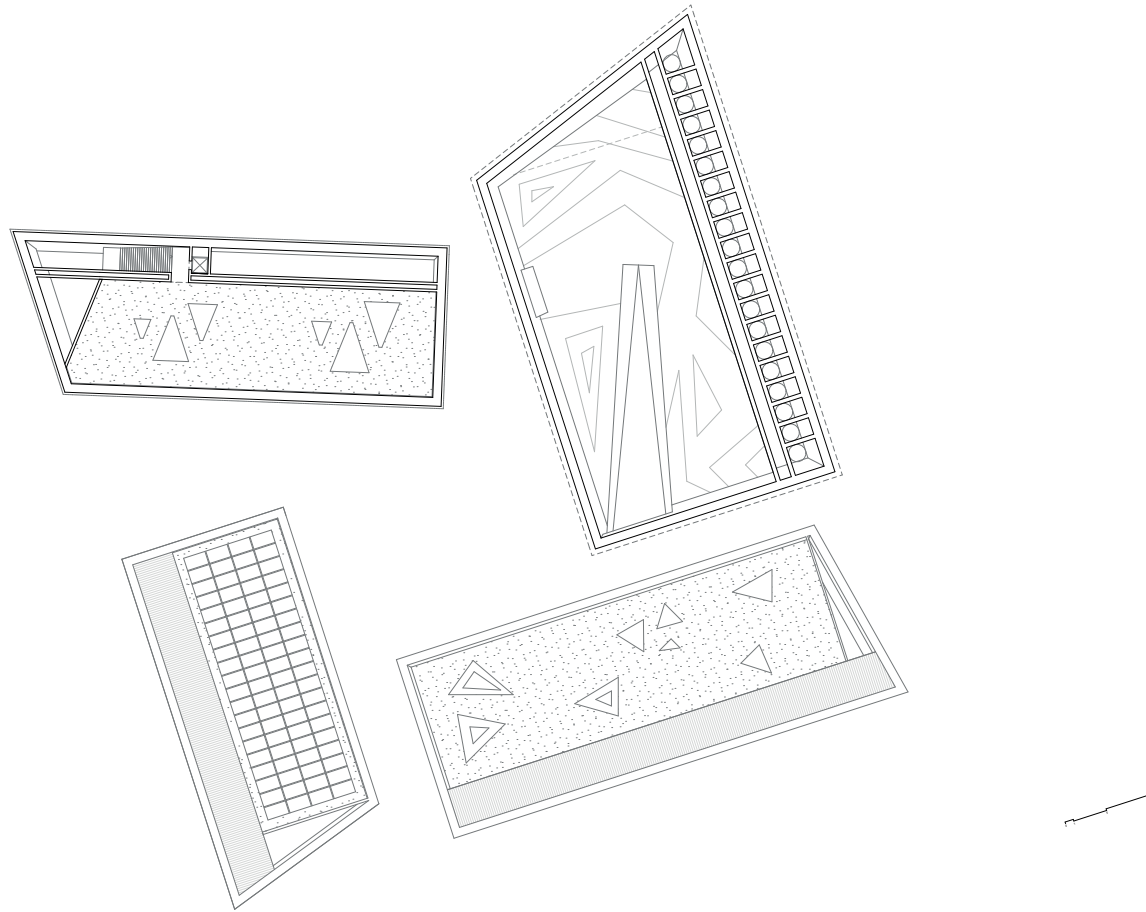

GRUNDRISS 3.OG

Meet Blue Sea | Maritorium | Laura Herndl, Michael Minton

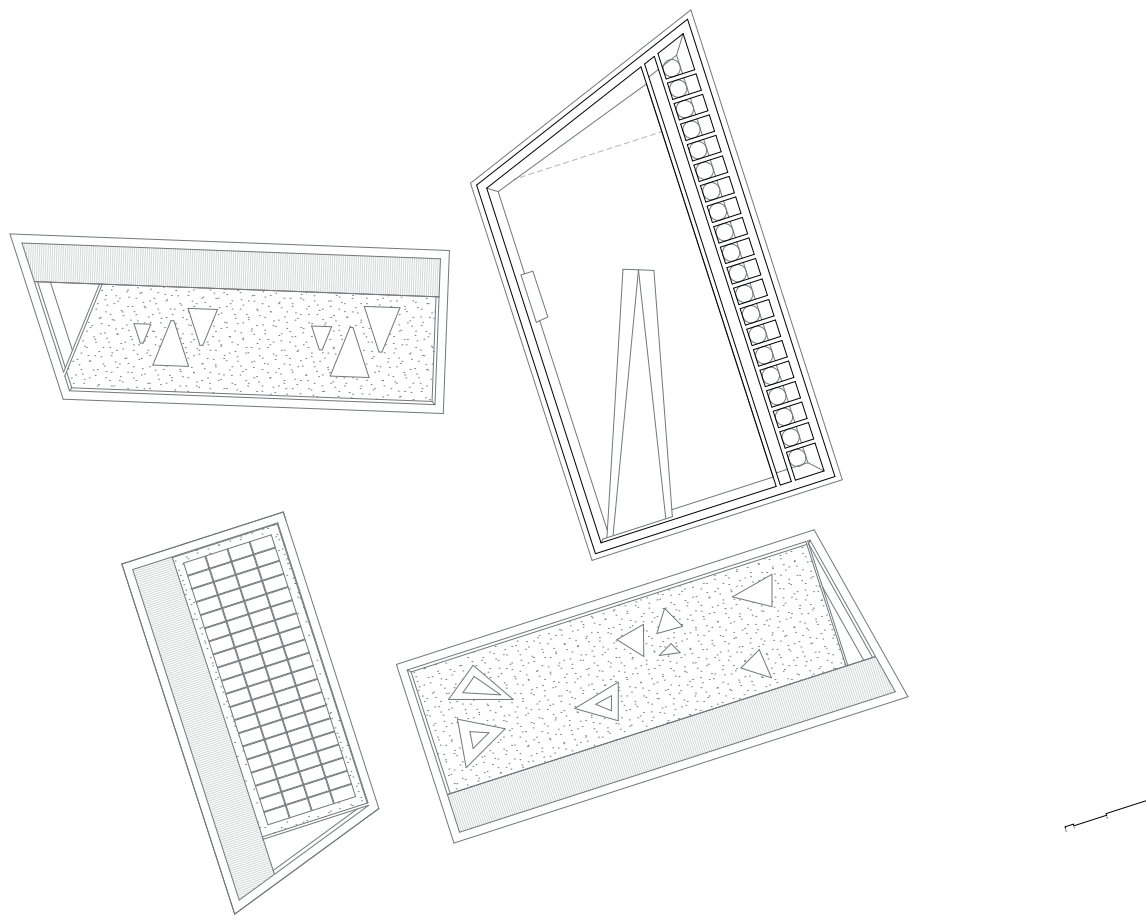

GRUNDRISS 4.OG

Meet Blue Sea | Maritorium | Laura Herndl, Michael Minton

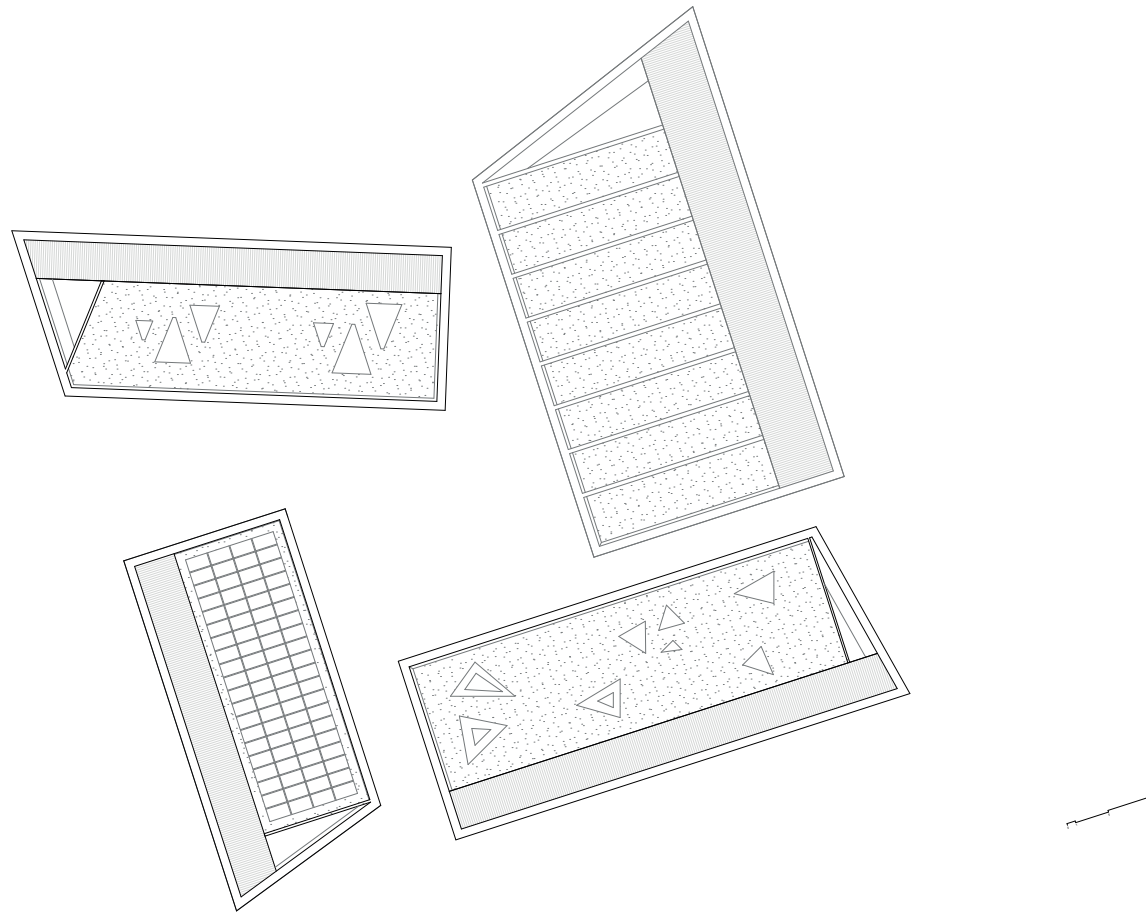

GRUNDRISSE DG

Meet Blue Sea | Maritorium | Laura Herndl, Michael Minton

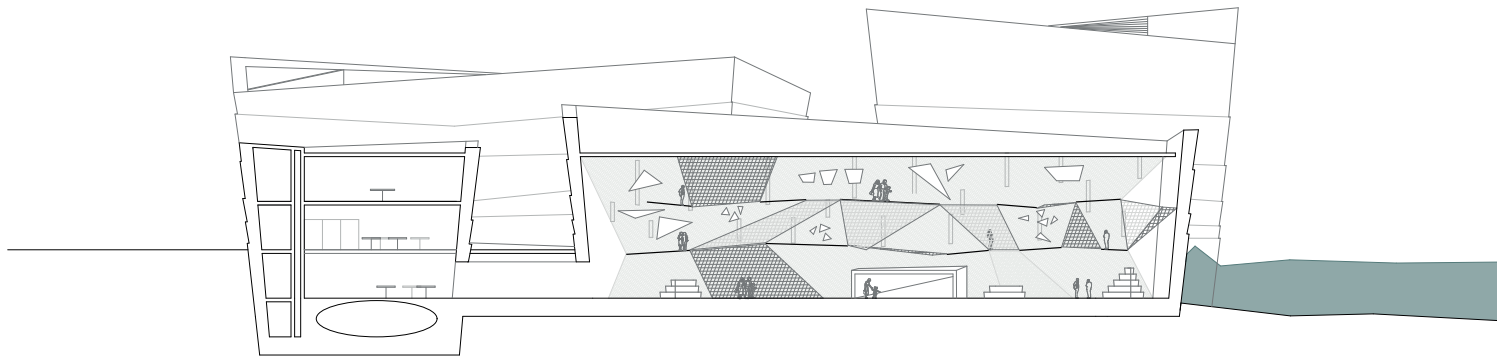
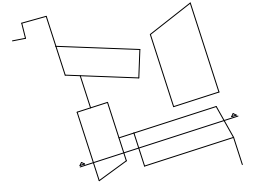

SCHNITT AA

Meet Blue Sea | Maritorium | Laura Herndl, Michael Minton

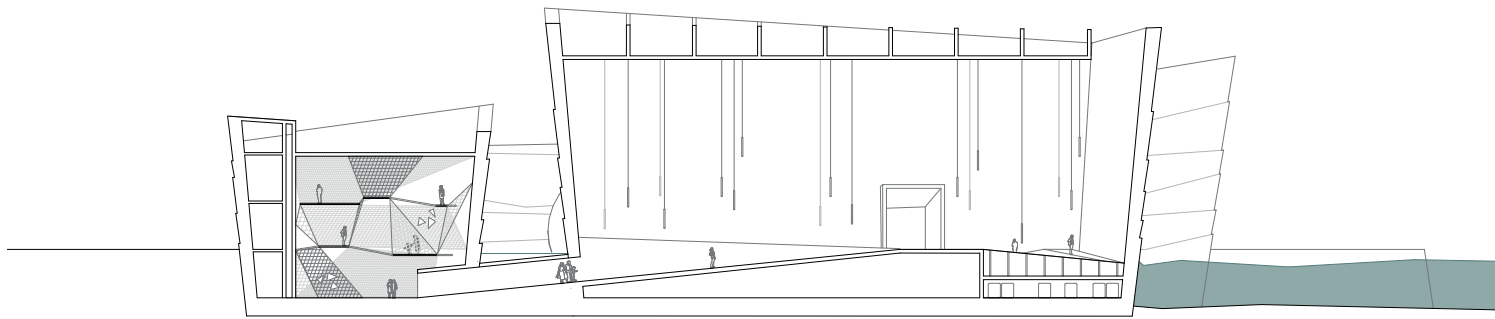
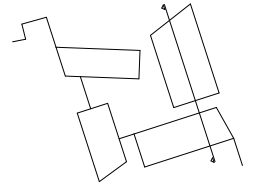

SCHNITT BB

Meet Blue Sea | Maritorium | Laura Herndl, Michael Minton

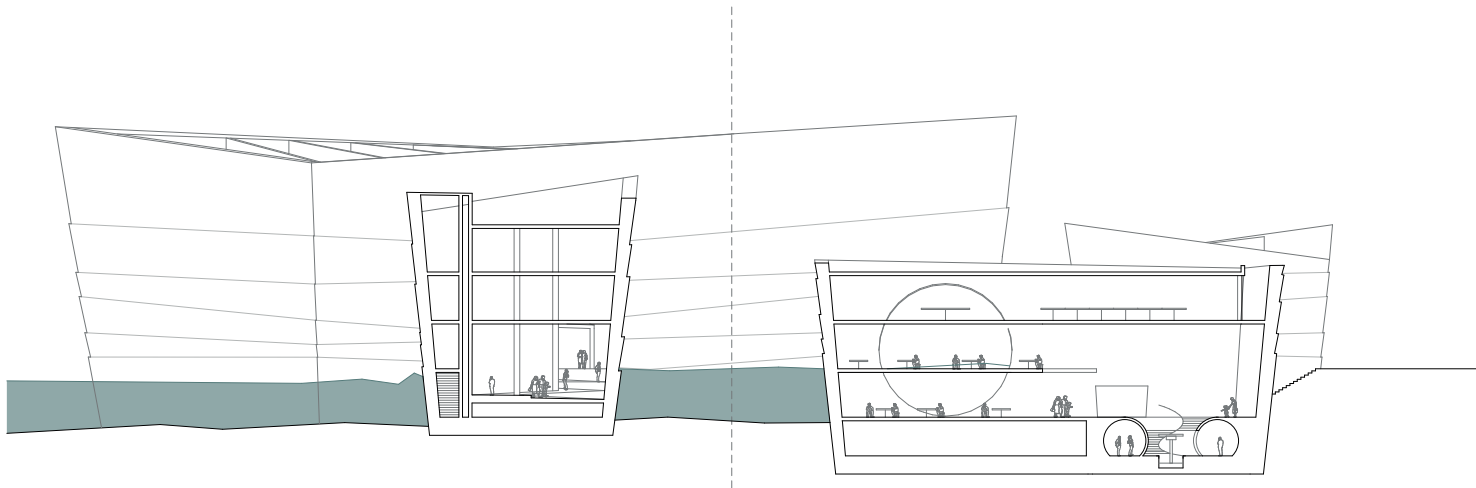
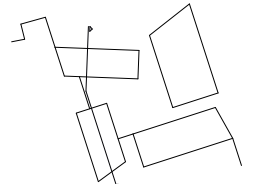

SCHNITT CC

Meet Blue Sea | Maritorium | Laura Herndl, Michael Minton

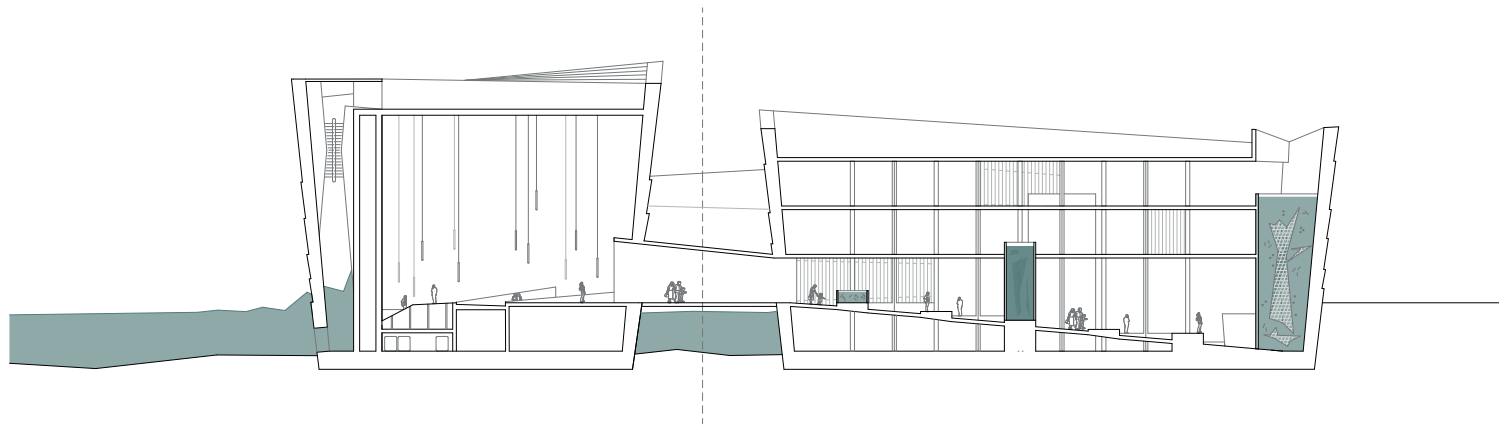
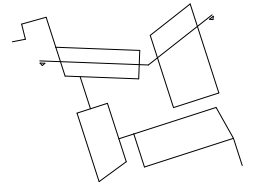

SCHNITT DD
Meet Blue Sea | Maritorium | Laura Herndl, Michael Minton

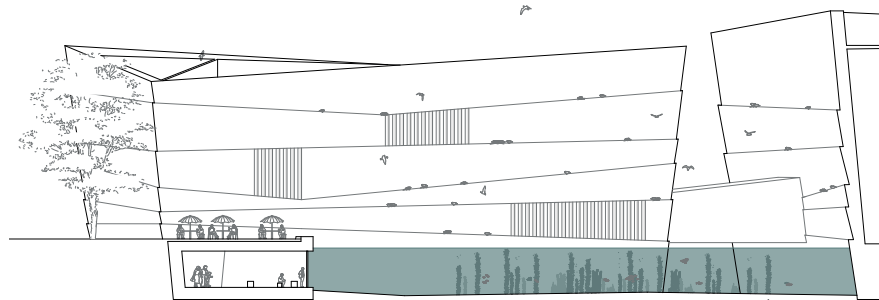
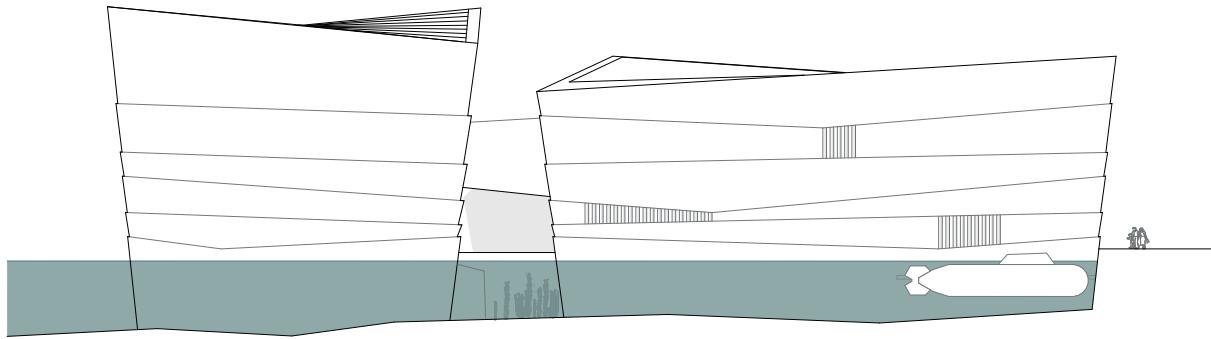

NORDANSICHT | HOFANSICHT

Meet Blue Sea | Maritorium | Laura Herndl, Michael Minton

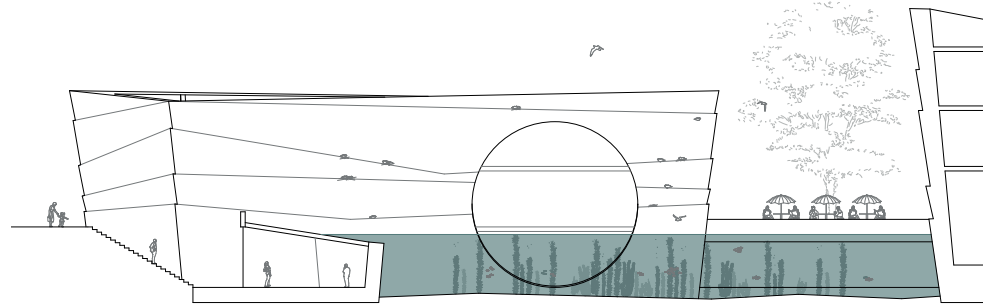
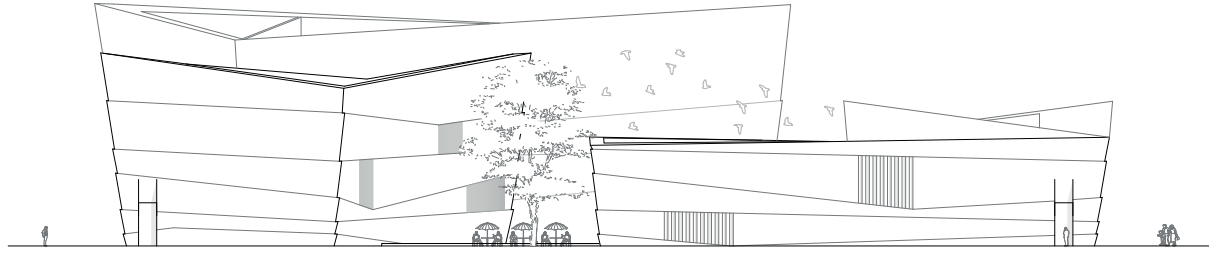

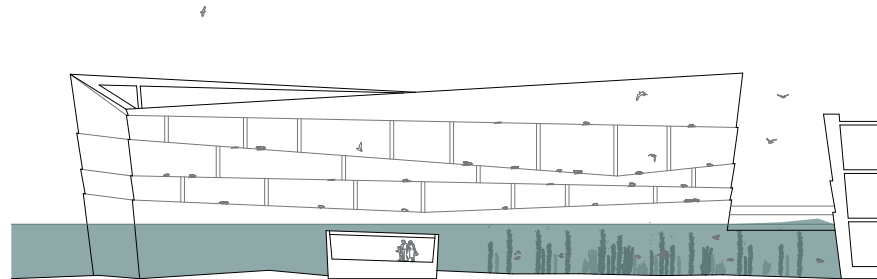
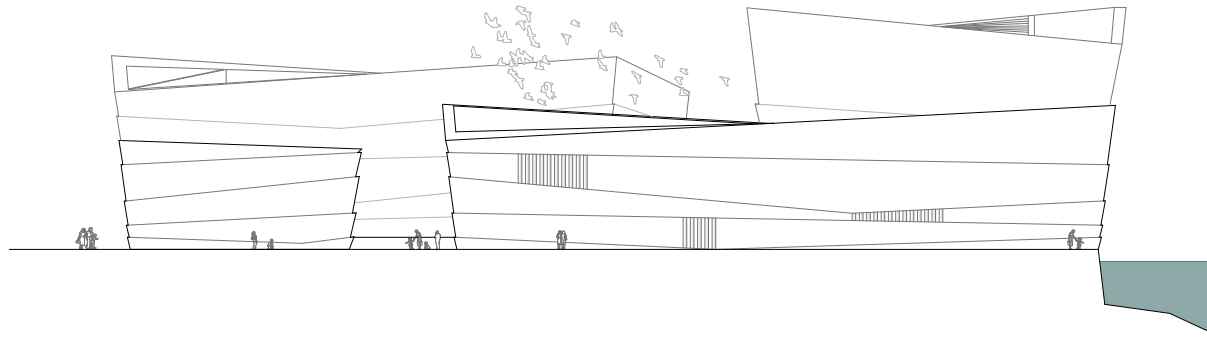

SÜDANSICHT | HOFANSICHT

Meet Blue Sea | Maritorium | Laura Herndl, Michael Minton

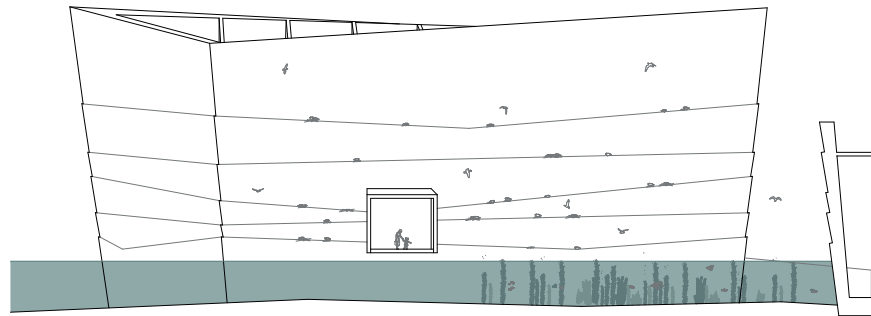
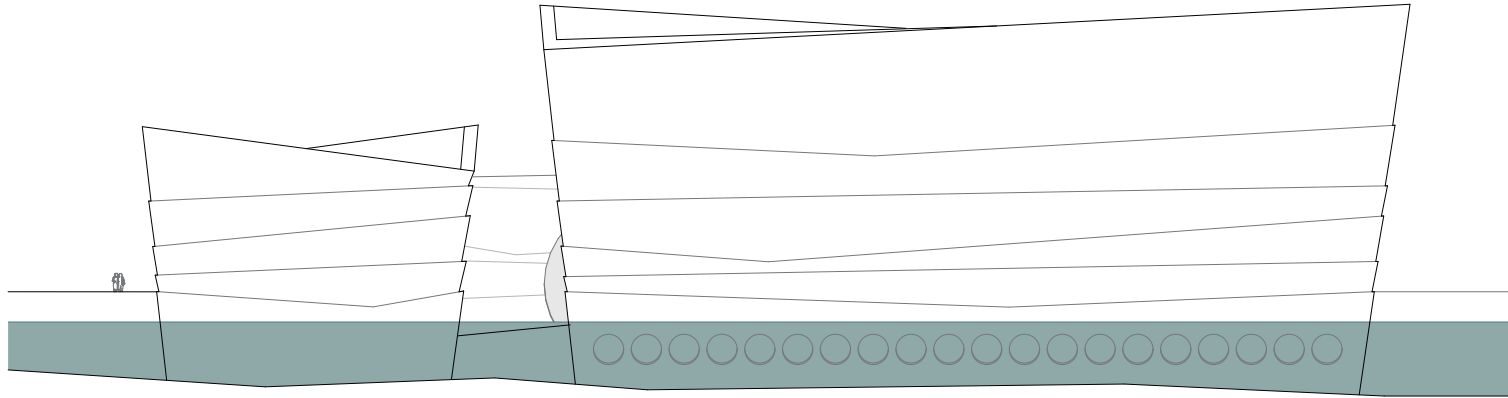

WESTANSICHT | HOFANSICHT

Meet Blue Sea | Maritorium | Laura Herndl, Michael Minton

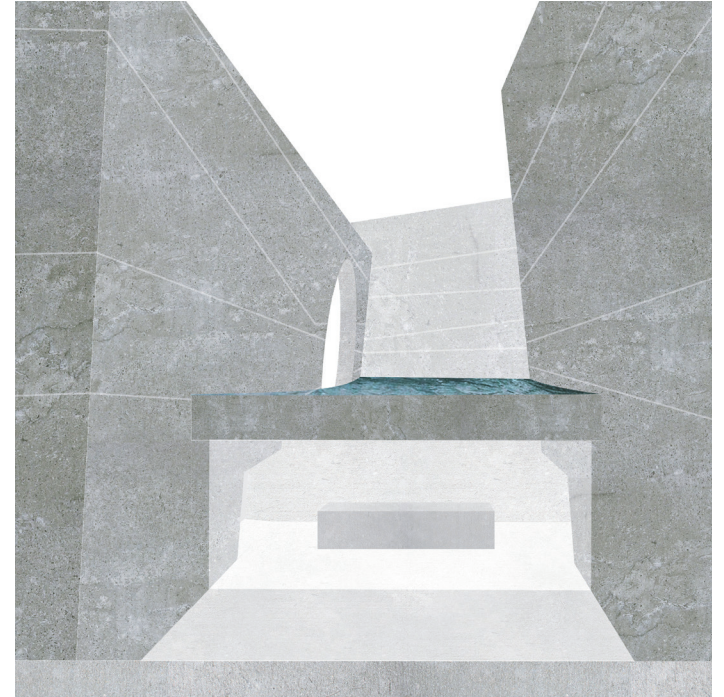
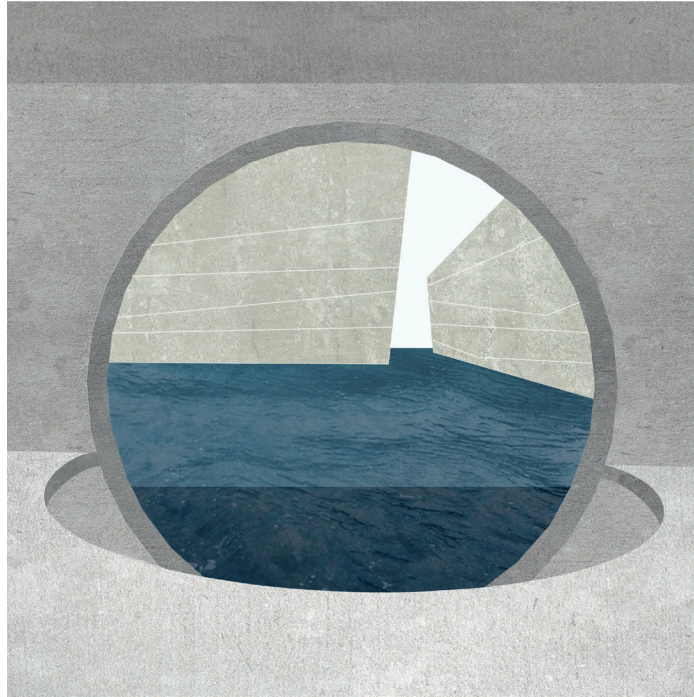
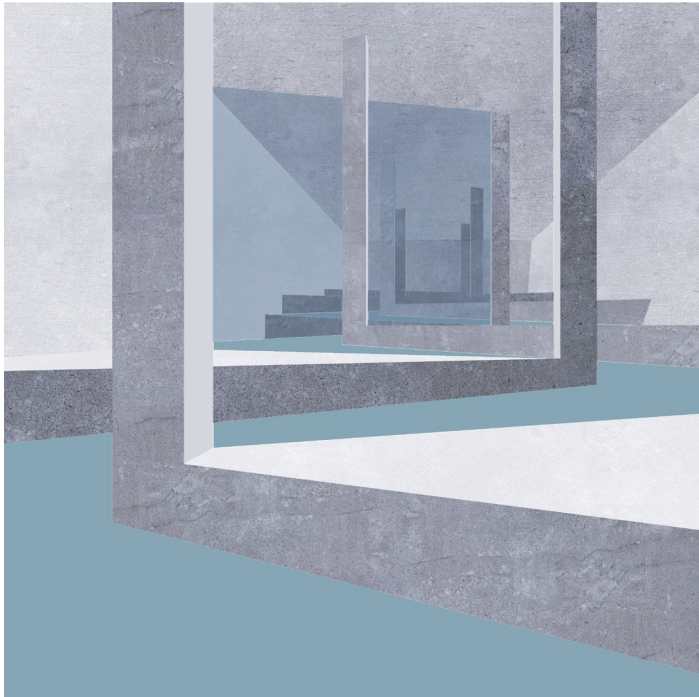

INNENRAUMPERSPEKTIVEN

Meet Blue Sea | Maritorium | Laura Herndl, Michael Minton

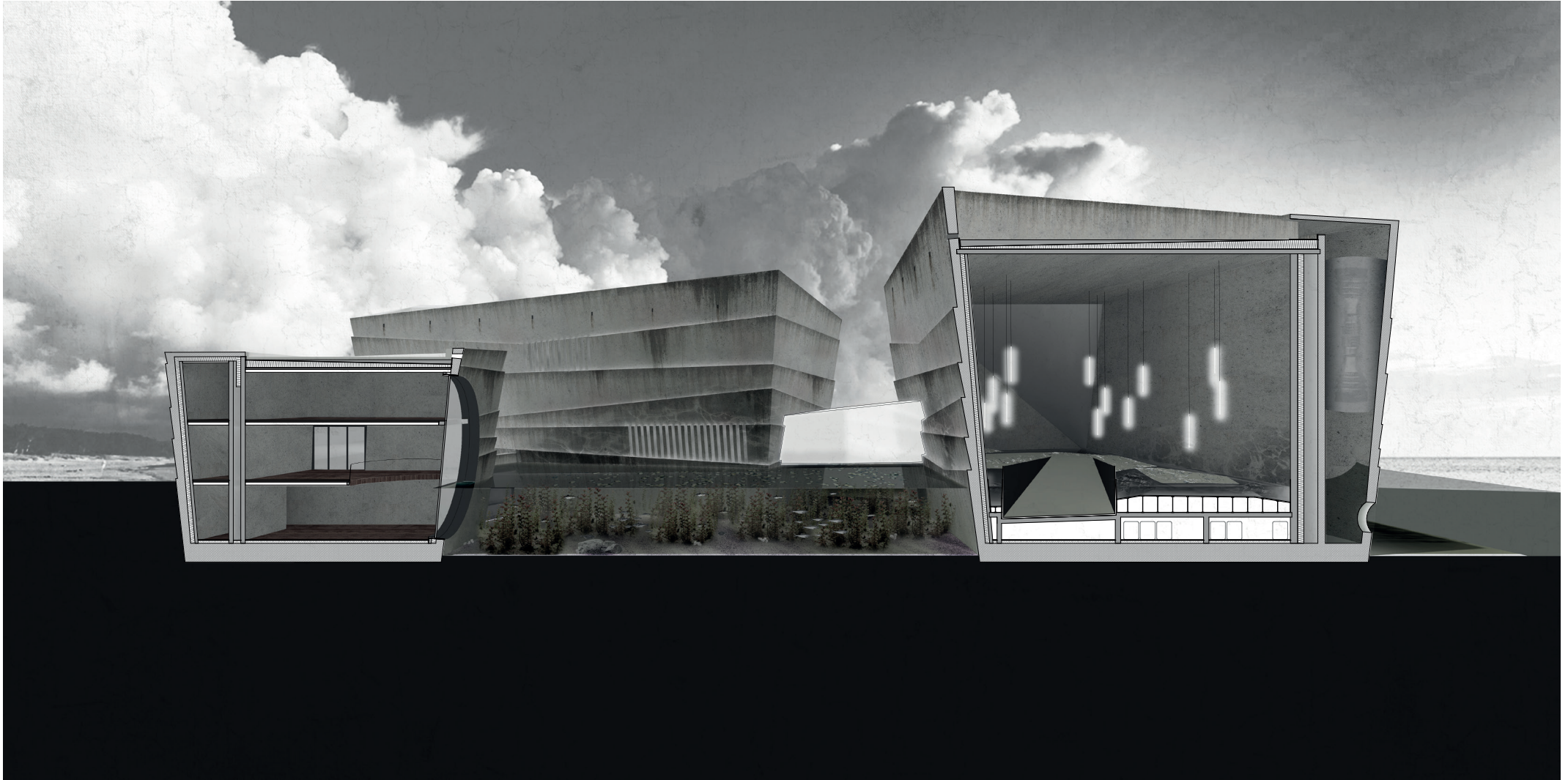

SCHNITTPERSPEKTIVE

Meet Blue Sea | Maritorium | Laura Herndl, Michael Minton



AUSSENRAUMPERSPEKTIVE

Meet Blue Sea | Maritorium | Laura Herndl, Michael Minton

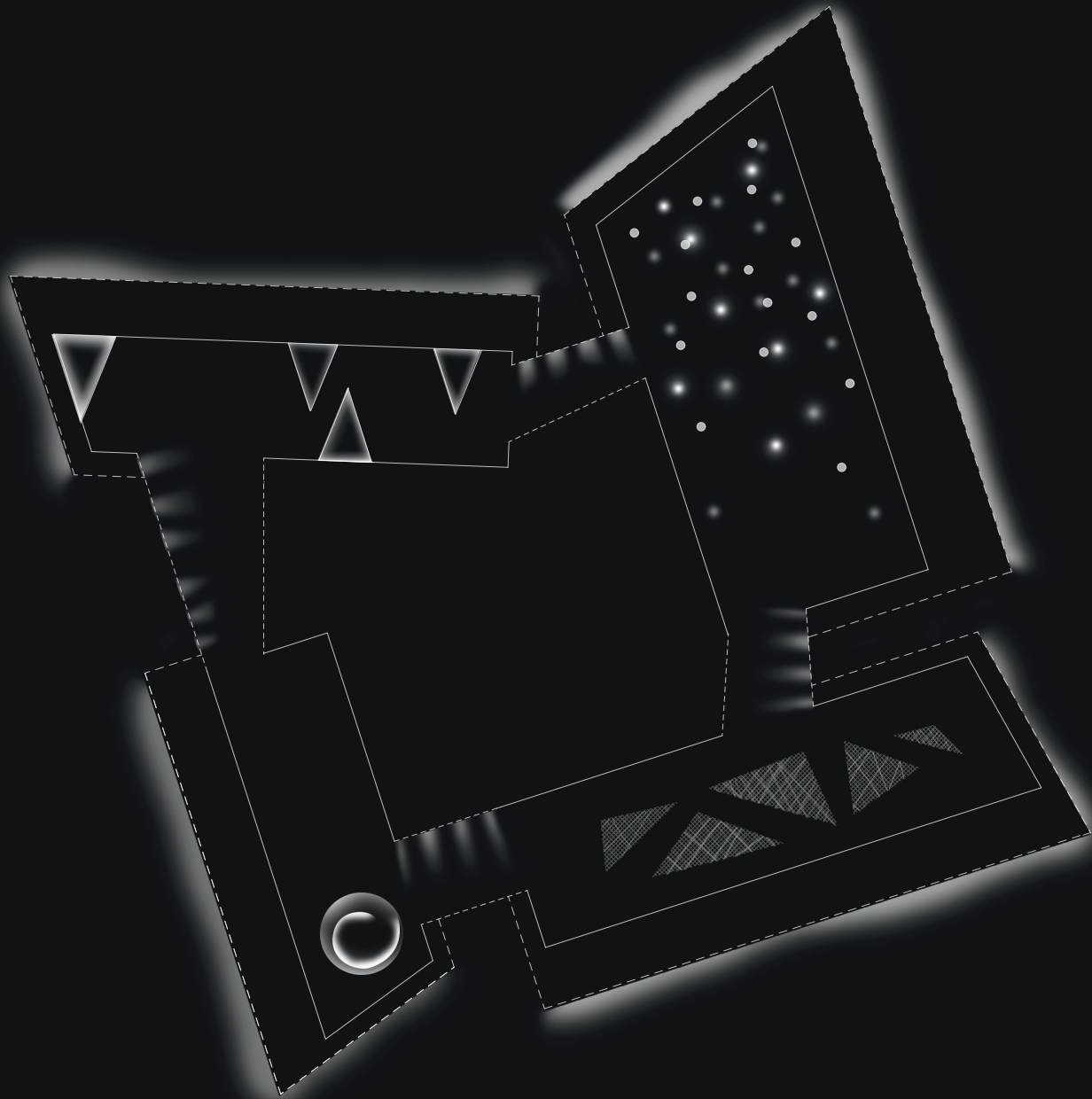

LICHTKONZEPT

Meet Blue Sea | Maritorium | Laura Herndl, Michael Minton

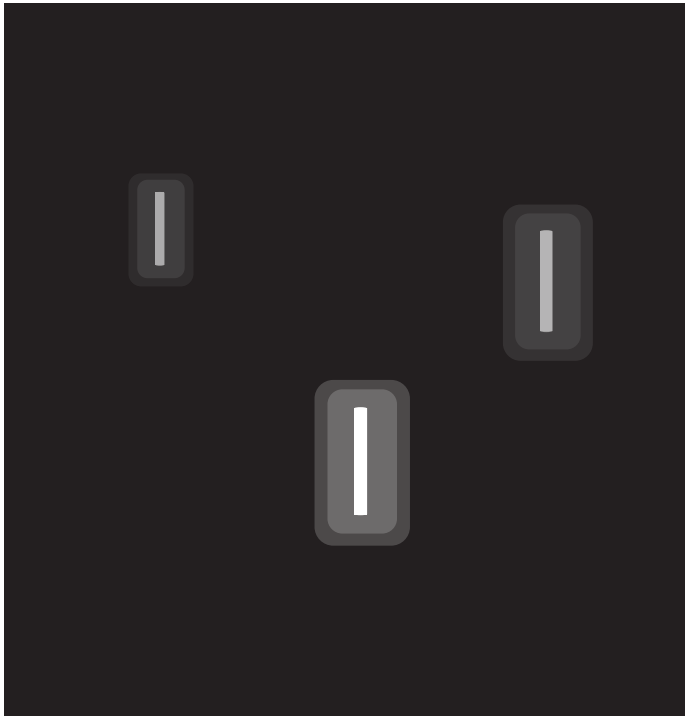

PUNKTUELLES LICHT

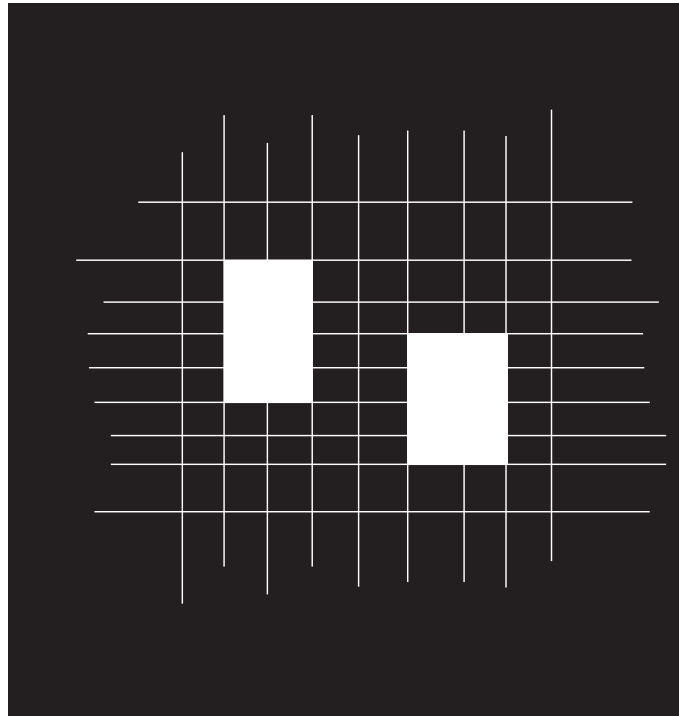

LINEARES LICHT

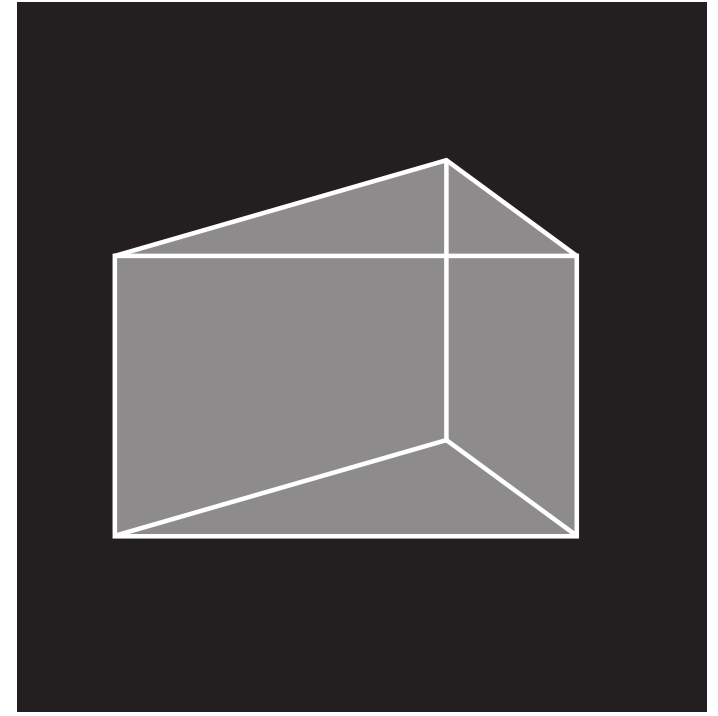

FLÄCHIGES LICHT

LICHTKONZEPT

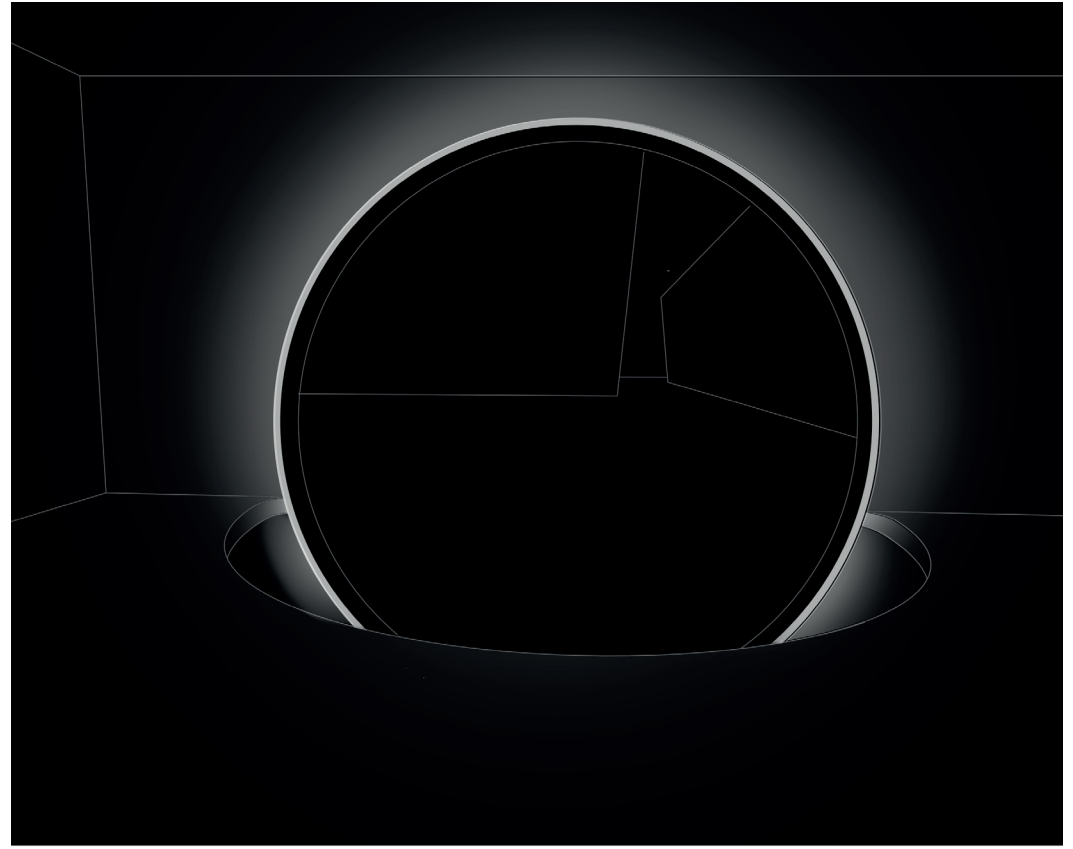
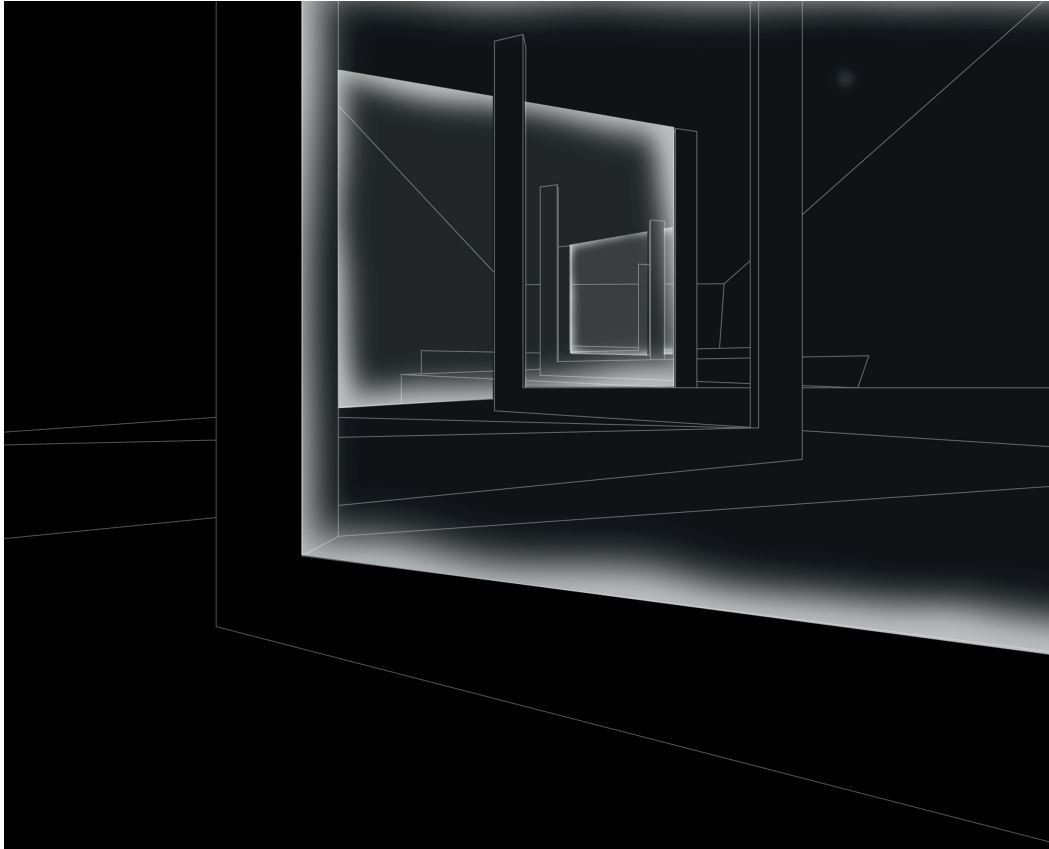

INNENRAUM BELEUCHTUNG

Meet Blue Sea | Maritorium | Laura Herndl, Michael Minton

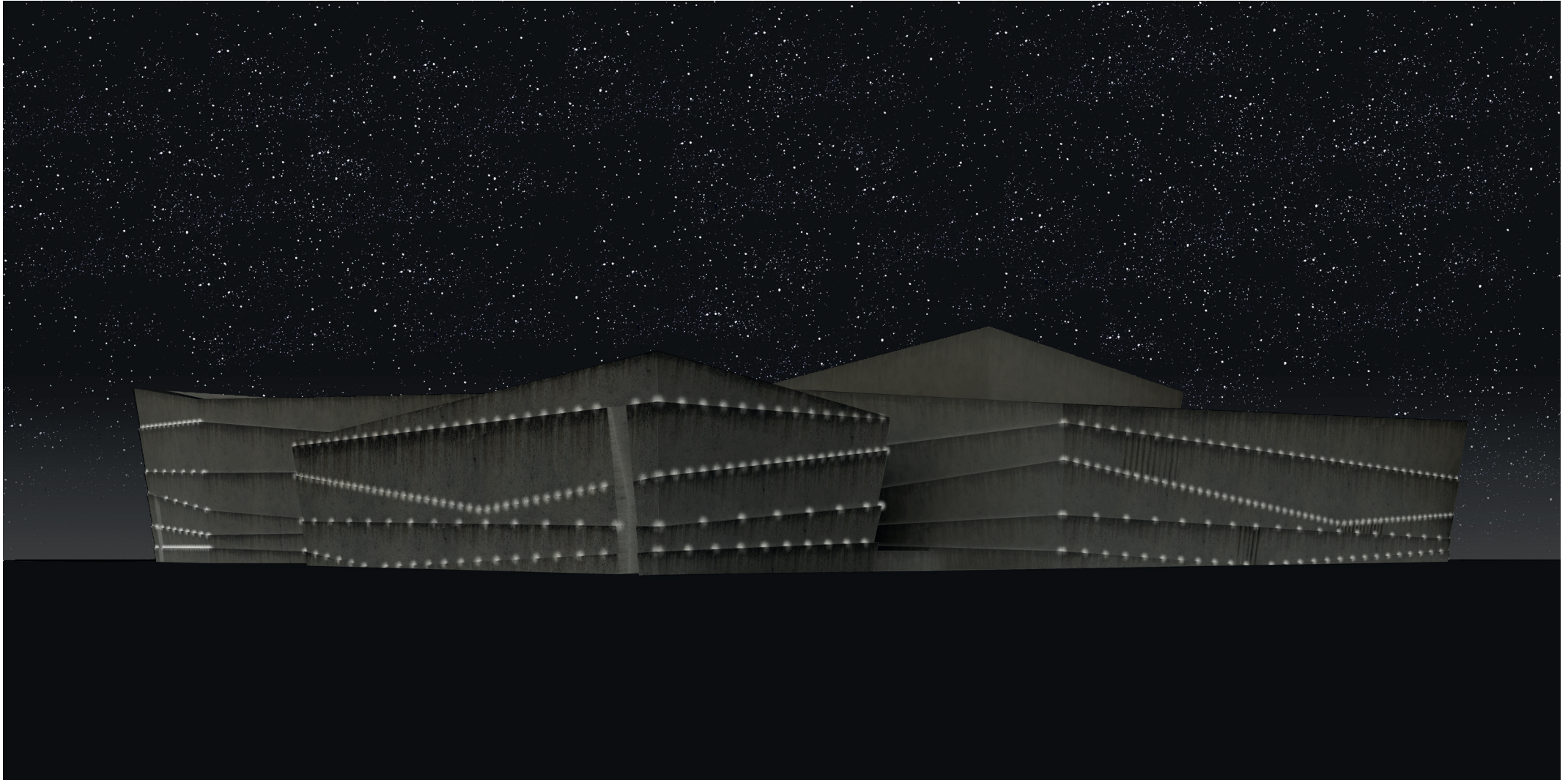

AUSSENRAUM BELEUCHTUNG

Meet Blue Sea | Maritorium | Laura Herndl, Michael Minton

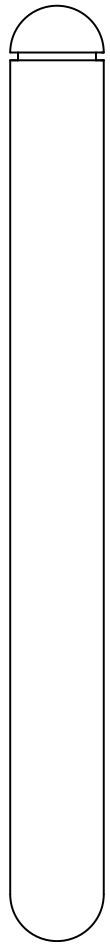

Ansicht 1



Ansicht 2

— Halterung
— Bewegungsmelder
— Technik

— Acrylglas



LEUCHTE | INNENRAUMPERSPEKTIVE

Meet Blue Sea | Maritorium | Laura Herndl, Michael Minton

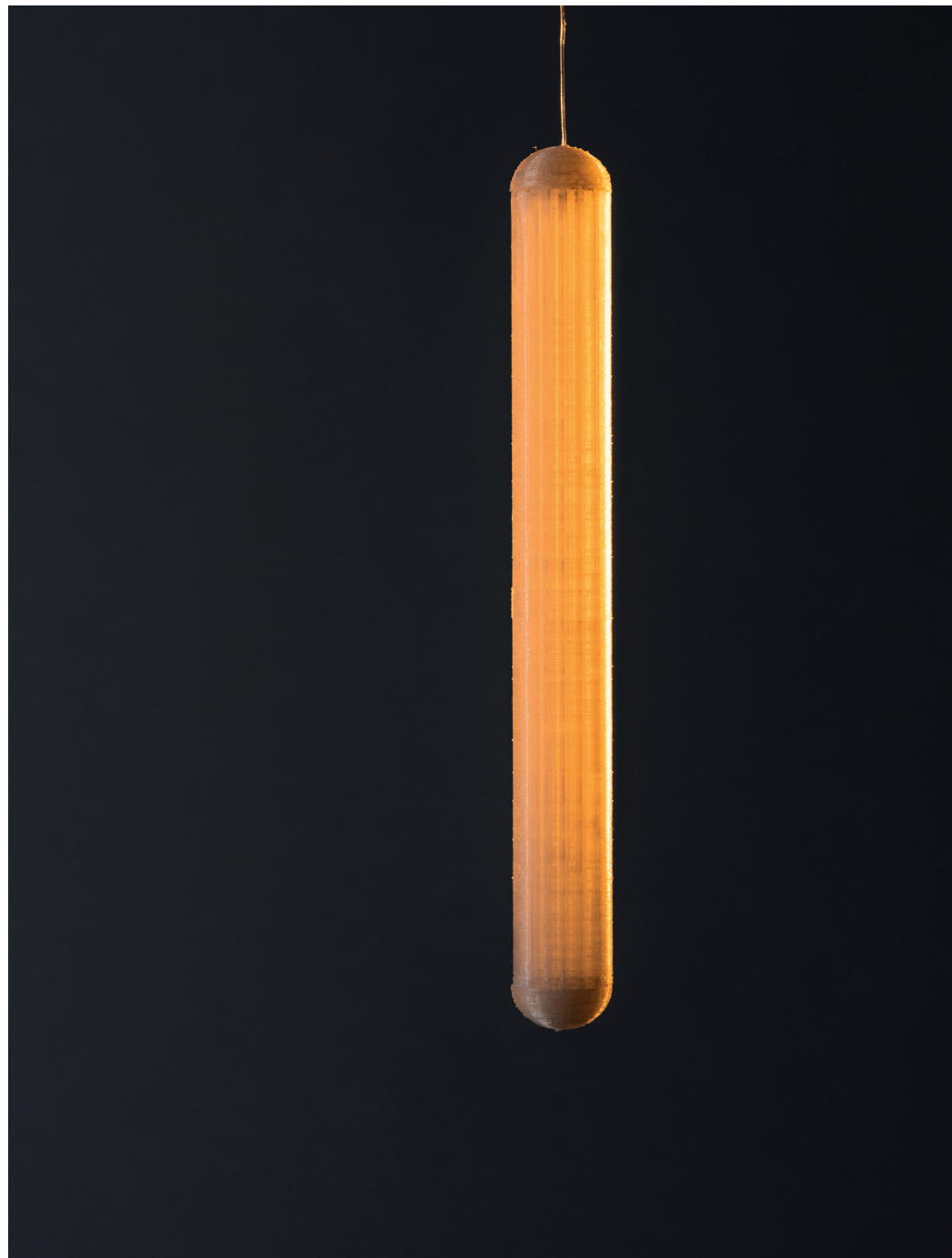
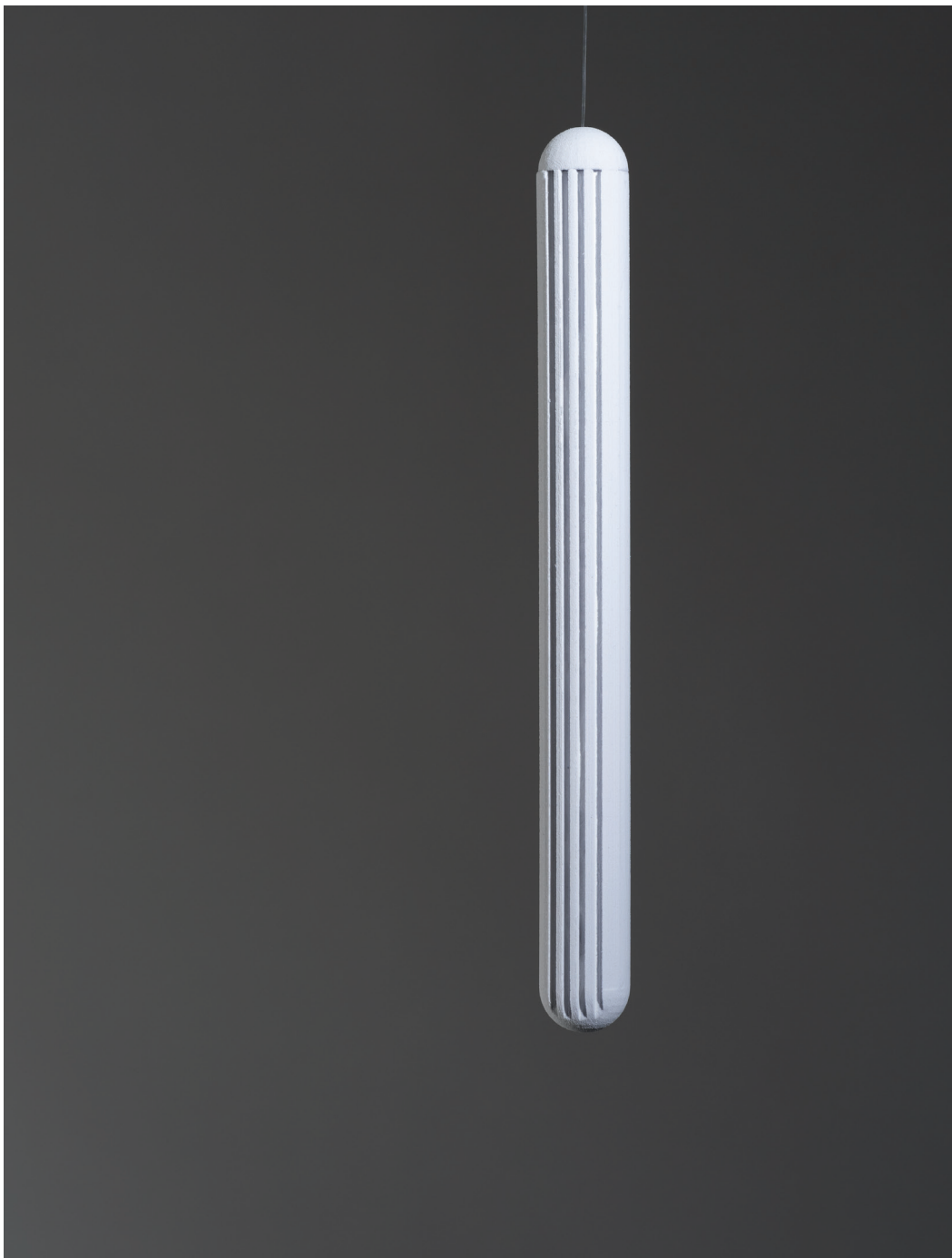

MODELLFOTO LEUCHTE © Tobias Adam
Meet Blue Sea | Maritorium | Laura Herndl, Michael Minton

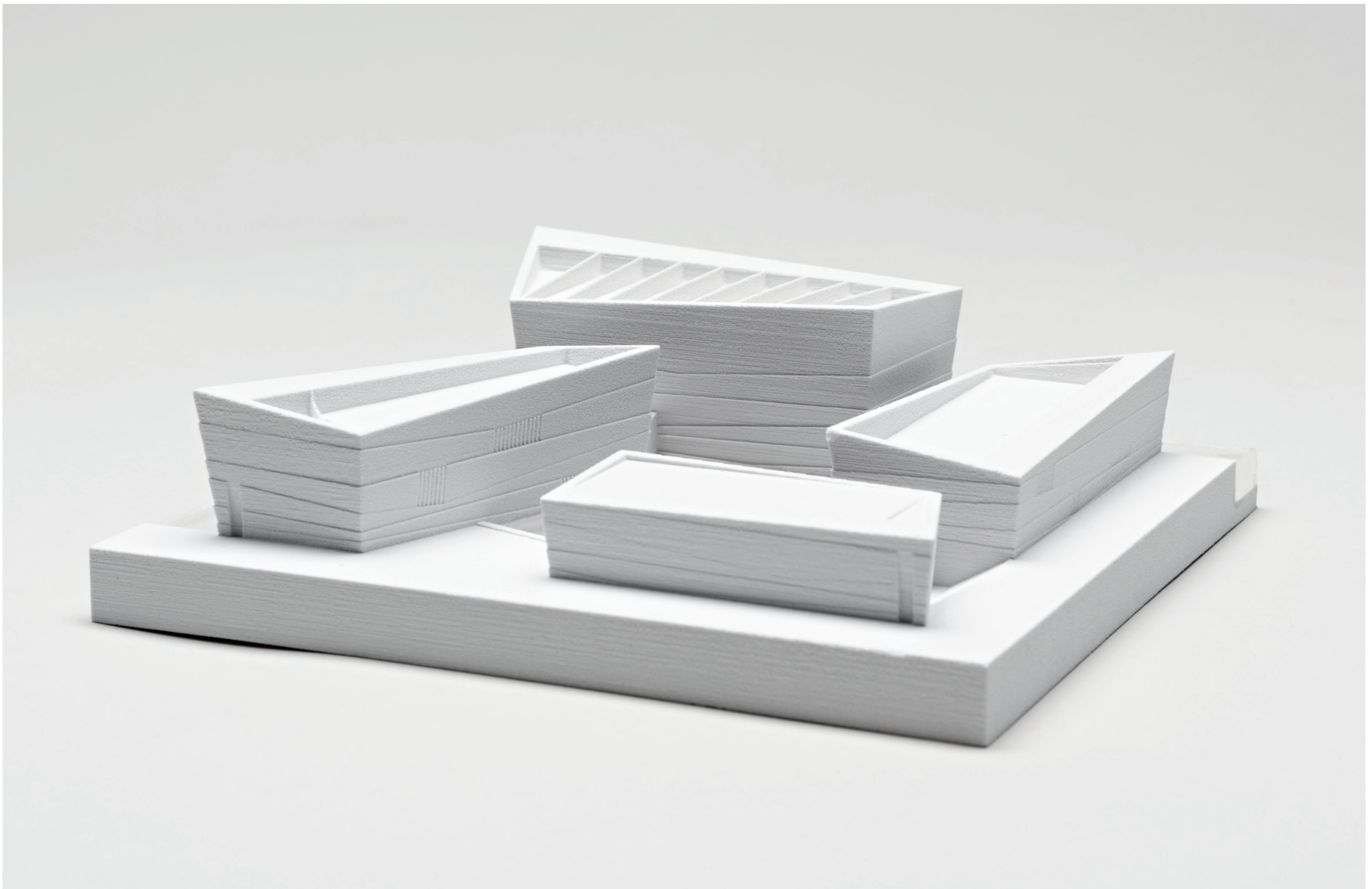

MODELLFOTO © Tobias Adam
Meet Blue Sea | Maritorium | Laura Herndl, Michael Minton

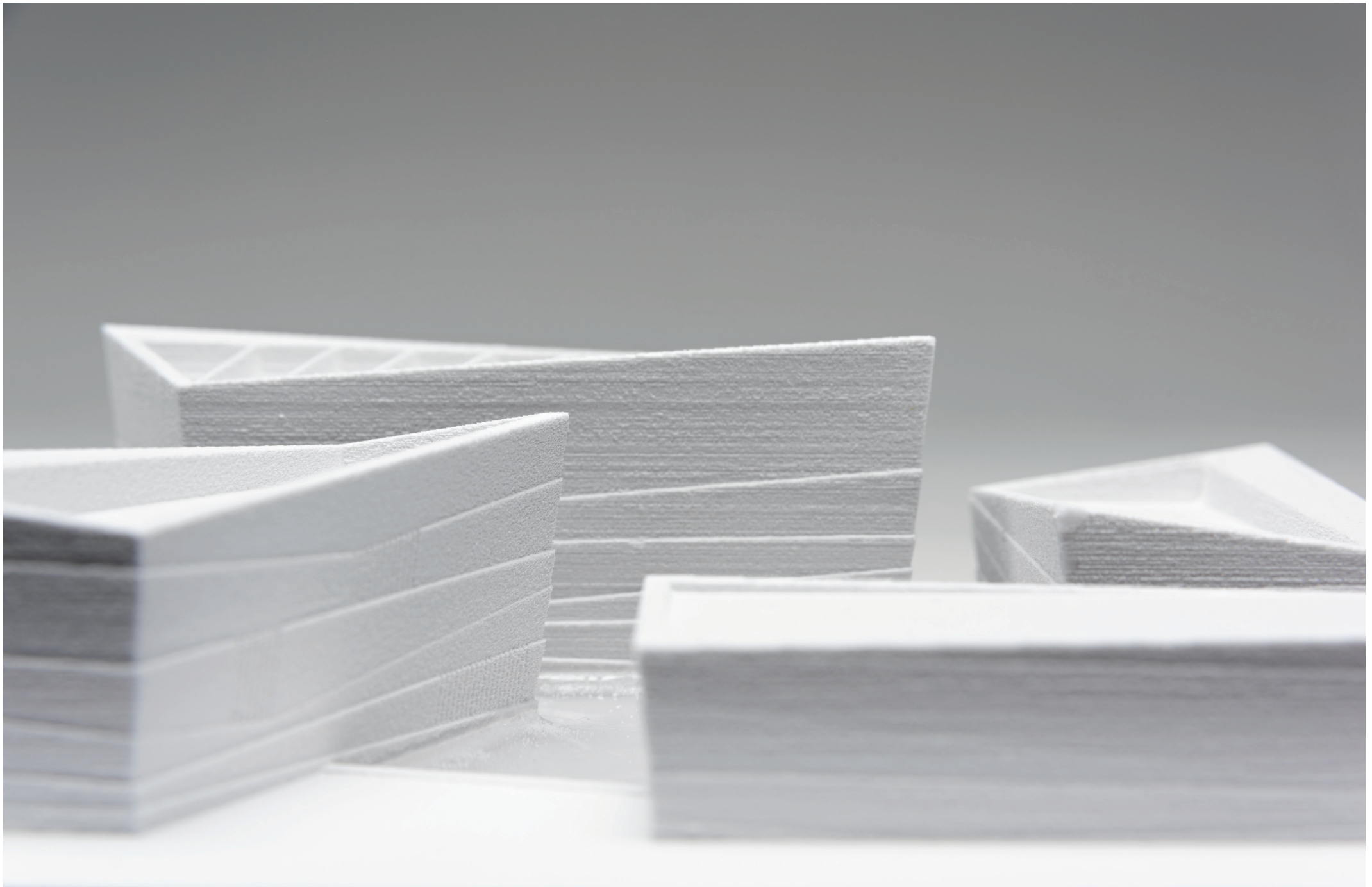

MODELLFOTO © Tobias Adam
Meet Blue Sea | Maritorium | Laura Herndl, Michael Minton



MODELLFOTO © Tobias Adam

Meet Blue Sea | Maritorium | Laura Herndl, Michael Minton

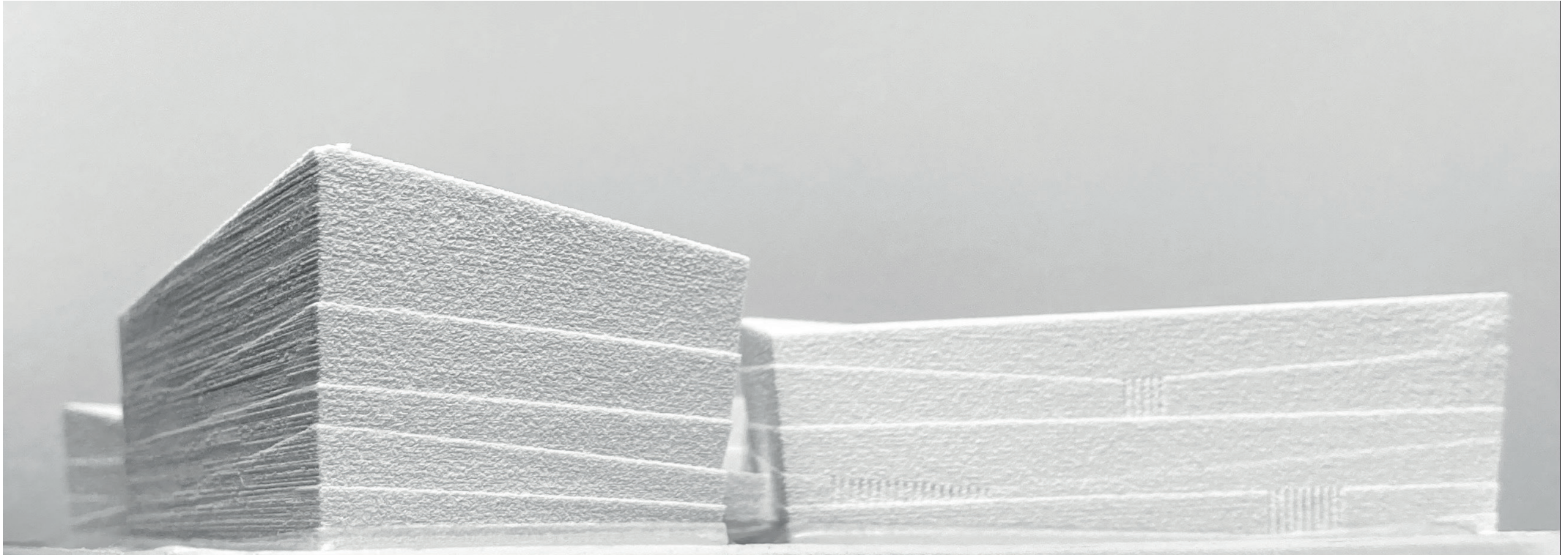

MODELLFOTO

Meet Blue Sea | Maritorium | Laura Herndl, Michael Minton

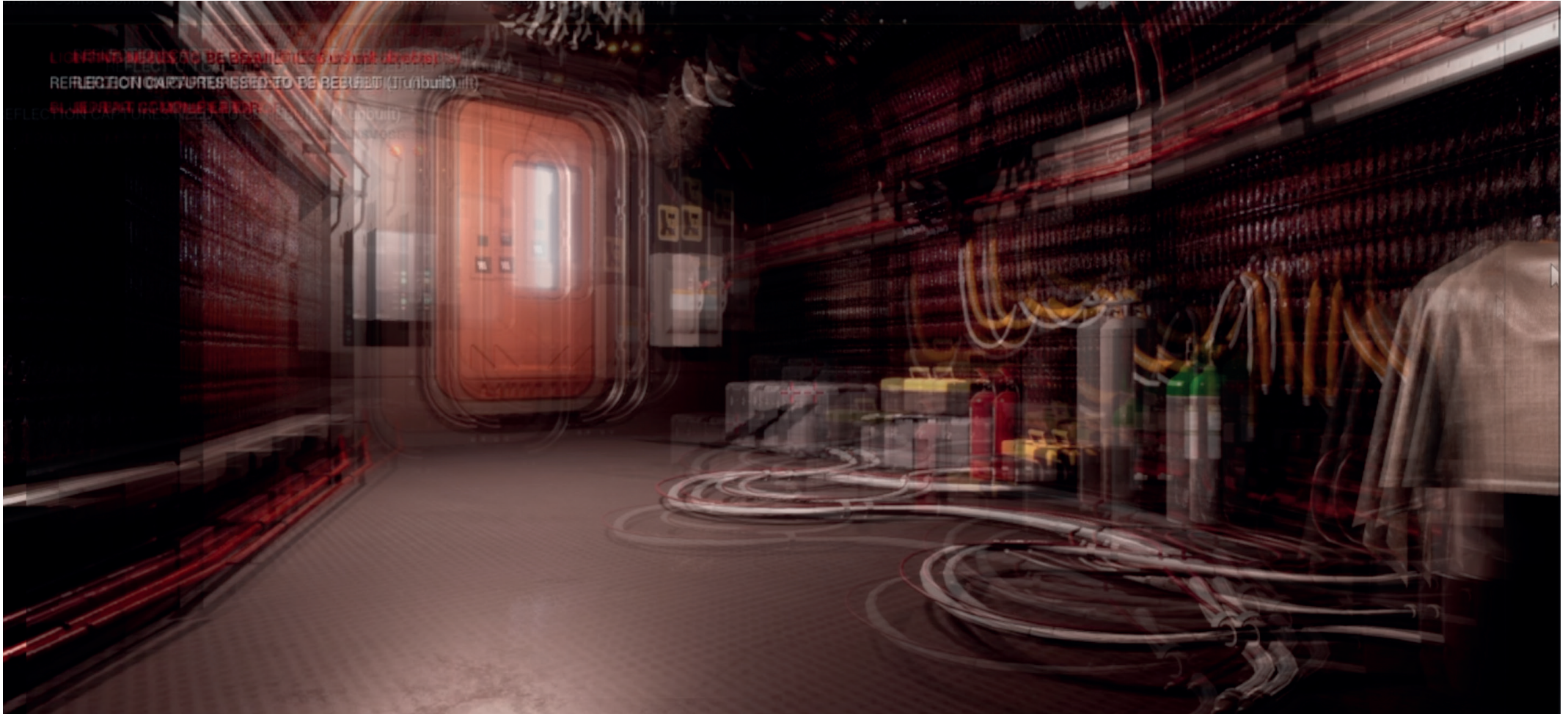

VR-ERLEBNIS „TRASH TOUR“

Meet Blue Sea | Maritorium | Laura Herndl, Michael Minton